

Haeger[®]

PEM SERTER[®]

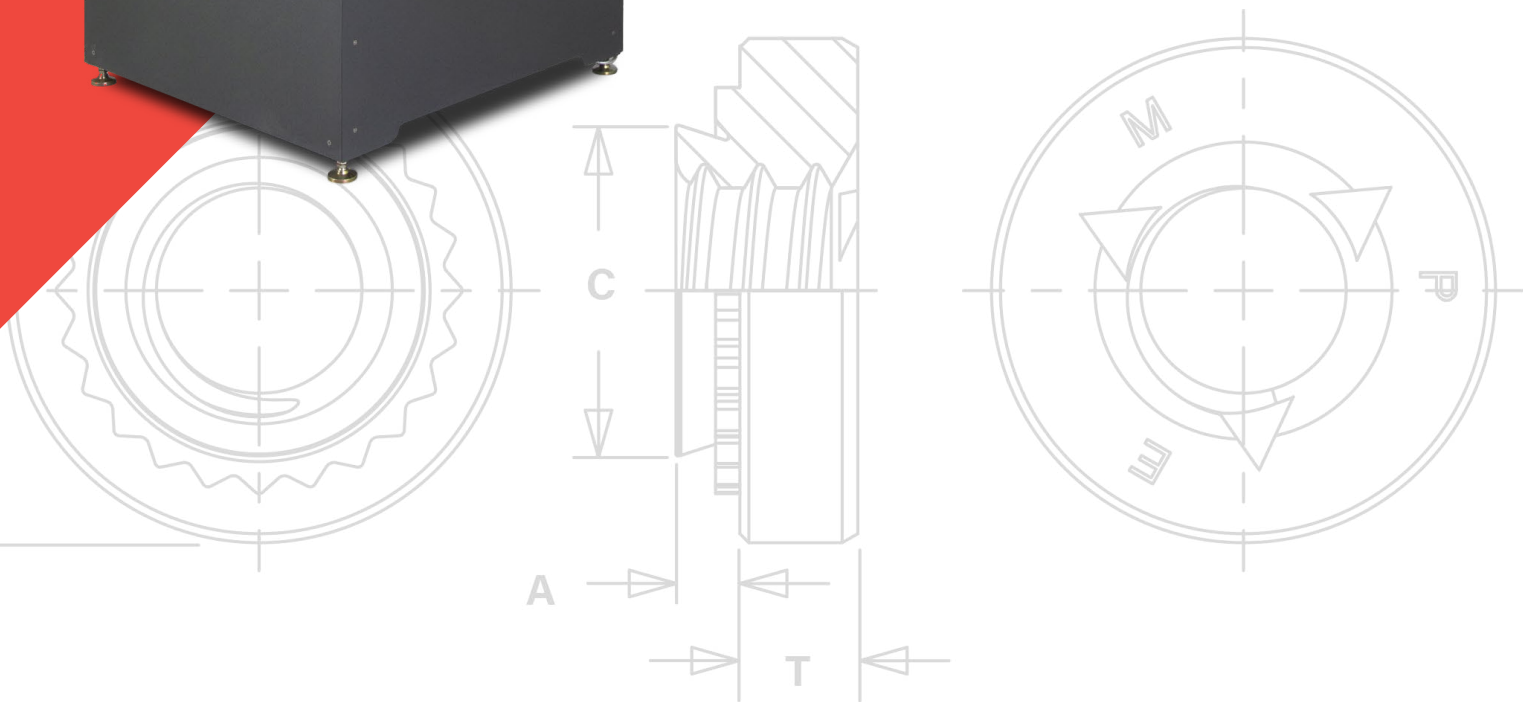

FASTENER INSERTION MACHINES



PennEngineering® designed and built the first **PEMSERTER**® automatic fastener installation machine in the 1960's as more and more self-clinching fastener users realized that further cost benefits could be achieved using auto feed equipment. This capability and product offering was expanded with the acquisition of **Haeger**® in 2018. Today PennEngineering® offers the most complete line of presses and in-die installation systems designed to safely, reliably, accurately, and quickly install the complete line of PEM® fasteners.

Haeger®, a PennEngineering® Company, is the world leader in the development of innovative fastener insertion technology solutions. Haeger® has introduced its full line of machines which provide our SingleTouch Part Handling Technology. These machines allow the insertion of up to four different fasteners in a single handling of a part. The Technology offers the single most significant boost to hardware insertion productivity since the introduction of automatic tooling systems. Haeger® machines Create Hardware Insertion Profit Centers™ by optimizing labor, improving quality, and increasing productivity through the use of technology.

We're constantly creating new technologies for inserting nearly every type and size of self-clinching fasteners into all varieties of materials. Our engineers can solve insertion challenges that no one else can, whether it's engineering, production, technical service or sales and marketing. Our staff brings experience, expertise, and diversity of talent second to none.

Haeger® Fastener Insertion Technology

The Most Cost Effective Solution for Your Fastener Insertion Challenge.



PEMSERTER®
Series 4®



Haeger® 618™
MSP 5e



Haeger® 824™
MSP 5e



Haeger® 824™
WindowTouch® 5e



Haeger® 824™
OneTouch™ 5e Lite



Haeger® 824™
OneTouch™ 5e

Haeger® NEW 5e Series Control System

Powered with the Technology You Need to Work More Efficiently

With the new Haeger® 5e Series Control System, you get the latest technologies that are defining the future of manufacturing and driving faster, more efficient, more productive business.

Industry 4.0

With seamless data collection, it's easier than ever to measure and optimize your most important manufacturing processes and make informed decisions that drive better cost savings and performance.

- Quality Assurance
- Compliance
- Maintenance
- Assembly Line Efficiency
- Automation

Remote Diagnostics

Remote diagnostics technology, using Team Viewer, ramps up your productivity by keeping machines running with fewer resources, from any location – while limiting travel and increasing the safety of your technicians

Take your manufacturing line to the next level of technology with the newest line of Haeger® 5e Control Systems.

Learn more at Haeger.com or contact our team today.



- ✓ Faster Troubleshooting
- ✓ Accurate Diagnostics
- ✓ Maintenance Planning
- ✓ Increased Uptime
- ✓ Proactive Monitoring

Installation Equipment Selector Guide

Installation Equipment	Max. Force	Throat Depth	Page No.
AUTOMATIC FEED			
HAEGER® 824™ OneTouch™ 5e	16,000 lbs. (72 kN)	24" (61 cm)	6-7
HAEGER® 824™ OneTouch™ 5e LITE	16,000 lbs. (72 kN)	24" (61 cm)	8-9
HAEGER® 824™ WindowTouch® 5e	16,000 lbs. (72 kN)	24" (61 cm)	10-15
HAEGER® 824™ MSP 5e	16,000 lbs. (72 kN)	24" (61 cm)	16-17
HAEGER® 618™ MSP 5e	12,000 lbs. (53 kN)	18" (45.7 cm)	18-19
MANUAL FEED			
PEMSERTER® Series 4® Machine	12,000 lbs. (53 kN)	18" (45.7 cm)	20-21
HANDHELD			
PEMSERTER® Series P3® Tool	5,000 lbs. (22 kN)	3" (7.6 cm)	22
PEMSERTER® MICRO-MATE® Tool	2,500 lbs. (1,134 kg)	1.75" (4.5 cm)	23

Haeger® 824™ OneTouch™ 5e

Fastener Insertion System Combine Maximum Productivity and Process Control with Ease of Setup

4 Station Automatic Lower Tool Changer

An integrated cartridge with 4 tooling stations automatically retracts, indexes and positions up to 4 different tools in the lower tool holder.

Maximum accessibility around the lower tool allows for parts with tall flanges to fit on the machine.

4 Station Automatic Upper Tool Changer

4 Insertion Stations and 4 Tool positions provide the ability to automatically feed up to 4 different sizes and types of fasteners in one handling. Productivity of 1 insertion every 2.5 seconds, while tools are changed within 3 seconds. Fastener Detection and Fastener Length detection provides FULL process control in every station.

Fast & Easy Tooling Setup on 4 MAS 350 - Modular Autofeed Systems

A unique new drive system in combination with a complete new bowl design incorporating all the latest bowl feeding technologies. A long list of advantages, but what does this mean for you?

- Tool Change from 3 minutes to 3 seconds per MAS 350 through a one piece tool module.
- No more manual bowl setting required. Software automatically sets the proper vibration rate, air eject time and required air pressure to allow for failure free fastener feed. From a full bowl down to the last one out! Reliable Feeding. Faster Changeover. No Training Required.
- Larger bowl design in combination with new drive allows for fastener sizes M1.5 through M10 all to be fed in the same bowl.
- Deeper bowl design in combination with new bowl tooling design allows for fastener lengths up to 30mm all to be fed in the same bowl.
- New upper tool design allows use for quick change 1 piece tool module, resulting in faster and easier tool change.
- Change in bowl material resulting in fasteners becoming less dirty from "air-dust" or individual rubbing.
- Lower mounting position allowing for easier filling and emptying.



Easier and Faster Programming

The ALL NEW intuitive Insertion Logic™ Software with Insertion Graphics® and integrated Statistic Process Control allows for more functionality while reducing programming time. Version 12 Insertion Logic® provides you with the recommended operating time for the part programmed and stores any corrected errors during the insertion process, allowing you to provide this data with your deliveries to your customers.

Best Operator Ergonomics

Operator control pendant can be adjusted in 6 directions, allowing for easy access and the best view of screen instructions while standing up or sitting down.



Operator control pendant can be adjusted in 6 directions.

Specifications

Force Range Adjustable 800 lbs. (3.6 kN) to 16,000 lbs. (72 kN)

Throat Depth 24" (610 mm)

Stroke Length Adjustable 0 to 8.5" (0 to 220 mm)

Electrical 208 to 575 V 3 phase - 50 or 60 Hz

Motor 5 HP 3 Phase Low 16 A 208-240 V / High 9.6 A 380-480 V

Oil Tank Reservoir 22 gallons (83 liters)

Speed up to 1,400 insertions per hour

Repeatability +/- 2% of force setting

Weight 3,200 lbs. (1,452 kg)

Footprint 59"L x 40"W x 94"H (1499 mm x 1016 mm x 2388 mm)

Fastener Range .256 to 1/2" (M2 to M12)

For more information on the 824™ OneTouch™ 5e and other Haeger® products, visit our website at www.haeger.com or contact your authorized Haeger® distributor.

Haeger 824™ OneTouch™ 5e LITE

Fastener Insertion System Combine Productivity with Versatility and Ease of Setup

The new 824™ OneTouch™ 5e LITE brings you:

- ALL the advantages of the 824™ WindowTouch® 5e.
- A second Automatic Upper Station which changes the upper tools and insertion stations automatically.

Combine the full versatility of Haeger's 824™ WindowTouch® 5e with the productivity of the 824™ OneTouch® 5e. Enjoy fastener detection and stud and standoff length detection on 2 stations.





Dual station removed.

1. Easy and Fast Changeover to full 824™ WindowTouch® 5e Versatility.

The dual station Upper Tool changer features integrated connectors allowing for a 10 second changeover to any other tooling setup. No training required.

Specifications

Force Range	Adjustable 800 lbs. (3.6 kN) to 16,000 lbs. (72 kN)
Throat Depth	24" (610 mm)
Stroke Length	Adjustable 0 to 8.5" (0 to 220 mm)
Electrical	208 to 575 V 3 phase - 50 or 60 Hz
Motor	5 HP 3 Phase Low 16 A 208-240 V / High 9.6 A 380-480 V
Oil Tank Reservoir	22 gallons (83 liters)
Speed	up to 1,400 insertions per hour
Repeatability	+/- 2% of force setting
Weight	3,100 lbs. (1,406 kg)
Footprint	59"L x 40"W x 94"H (1499 mm x 1016 mm x 2388 mm)
Fastener Range	.256 to 1/2" (M2 to M12)

For more information on the 824™ OneTouch™ 5e Lite and other Haeger® products, visit our website at www.haeger.com or contact your authorized Haeger® distributor.

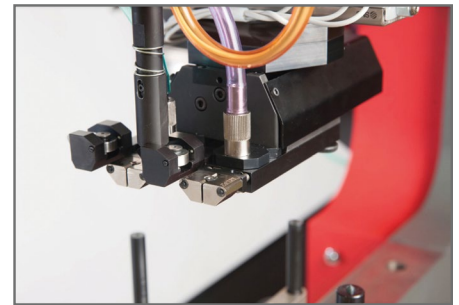

1. FROM STATION 1 TO STATION 2 - OPEN UPPER TOOL.

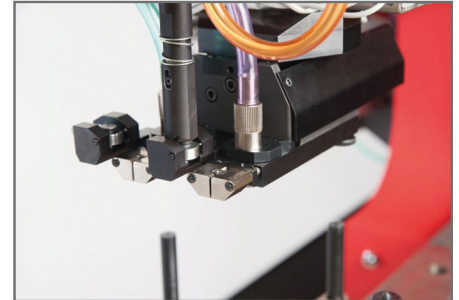

2. PICK UP NEW UPPER TOOL.

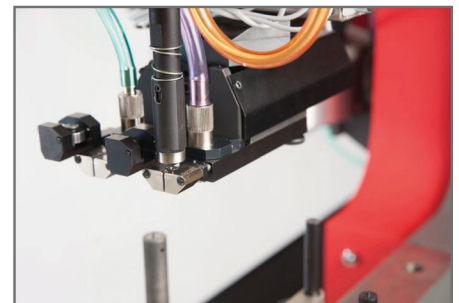

3. CLAMP TOOL AND MOVE INTO POSITION STATION 2.

Haeger® 824™ WindowTouch® 5e

Fastener Insertion System Versatility and Ease of Setup

The 824™ WindowTouch® 5e brings you:

1. Easier and faster tooling setup combined with the most reliable fastener feeding
2. Best workpiece accessibility
3. Easier and faster programming
4. Best Operator Ergonomics
5. Energy Saving

Learn how Haeger's mission can become your profitability

- Are you still handling your parts multiple times?
- Are you still manually feeding the majority of your fasteners?
- Are you still experiencing substantial setup times on both new and repeat jobs?
- Are you still under the assumption that setting up automatic tooling is too complicated or too time consuming?

Are you still experiencing:

- Missing fasteners?
- Fasteners inserted in the wrong location?
- Fasteners inserting on the wrong side of the part?
- Wrong length stud or standoff inserted?
- Parts scratched due to manual feeding in combination with multiple handlings?

We have taken your feedback seriously for many years and have developed multiple solutions to address the challenges you are facing. The integration of all these solutions are found in the 824™ WindowTouch® 5e.



Easier and Faster Tooling Setup

MAS 350 - New Modular Autofeed System.

A unique new drive system in combination with a complete new bowl design incorporating all the latest bowl feeding technologies.

A long list of advantages, but what does this mean to you?

- Tool Change reduced from 3 minutes to 3 seconds through a one piece tool module.
- No more manual bowl settings required. Software automatically sets the proper vibration rate, air eject time and required air pressure to allow for failure free fastener feed. From a full bowl down to the last one out. Reliable Feeding. Faster Changeover. No Training Required.
- Larger bowl design in combination with new drive allowing for fastener sizes M1.5 through M10 all to be fed in the same bowl.
- Deeper Bowl design in combination with new bowl tooling design allowing for fastener lengths up to 30mm all to be fed in the same bowl.
- New drive design allows for a 1 single tool piece, resulting in faster and easier tool changes.
- Change in bowl material resulting in fasteners becoming less dirty from "airdust" or individual rubbing
- Lower mounting position allowing for easier filling and emptying.

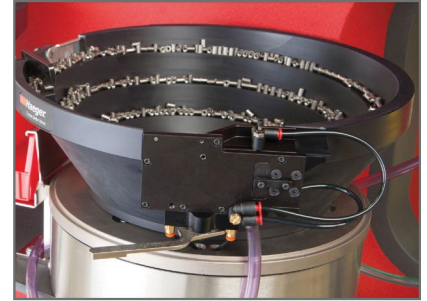

MAS 350 - new modular autofeed system.

New T-Bracket and Shuttle with integrated Connectors eliminating alignment challenges.

Fastest and easiest setup in the industry. Reduced from 2 minutes to 10 seconds without having to think about which connector goes where. On traditional machines, an operator had to change multiple air-lines and sensor cables, unnecessarily delaying changeover times. In addition, operators required training for alignment of the T-Bracket and shuttle, which has been eliminated with this new system. New re-designed Shuttle Plate Jaw Pins, eliminating breakage and saving cost for replacement and downtime.



New T-bracket and shuttle with integrated connectors.

Pre-aligned Base Plate

A pre-aligned base plate allows for easy tool holder changeover. No alignment of tools required. Where a tooling re-alignment after tool holder replacement used to take up to 5 minutes, this setup time has now been completely eliminated.

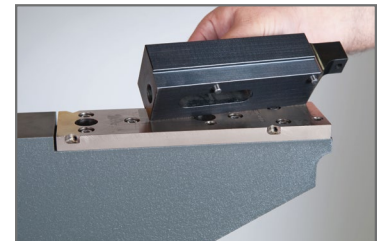

Pre-aligned lower tool holders.

Haeger 824™ WindowTouch® 5e

Fastener Insertion System - Best Workpiece Accessibility

Lower Support Arm.
200mm more access on lower support arm.

Through the use of built-in reinforcements and a change in frame design, the 824™ WindowTouch® 5e now offers more accessibility on the lower support arm.

- Haeger 824 Plus, 824WT-1, 824WT-2, 824WT-3
- Haeger 824WT-4e
- Haeger HP6

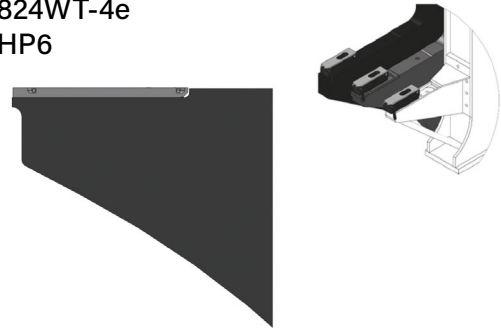

The "Star Design" Turret Insertion System (TIS) allows for access in "U-Shaped profiles". Compared to a round Turret Design, the Star Design offers maximum accessibility for a variety of pre-formed workpieces. The Turret Insertion System clamps the tools in position while providing Position Feedback, eliminating the famous "missing fastener" error.

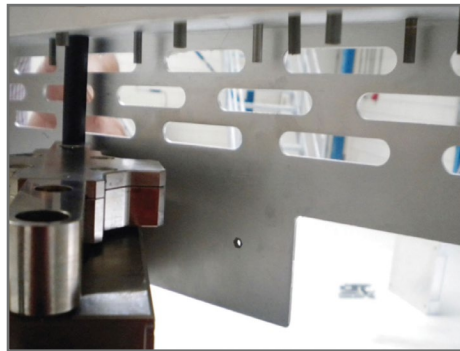
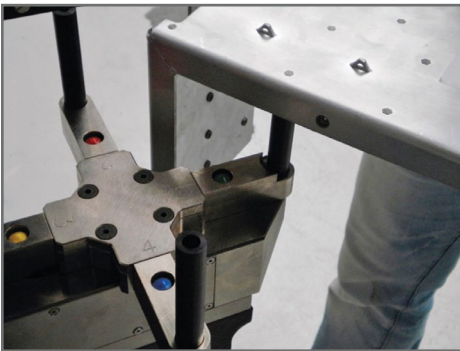

"Star Design" turret Insertion System (TIS).

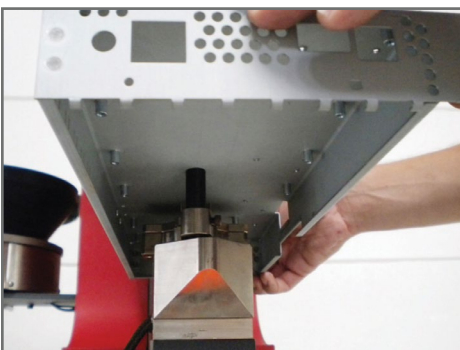

Turret arms removed.

The turret arms are individually removable, allowing for even more access while the position feedback (and process control) remains present.

Manual J-Frame with 24" (610mm) throat depth. Changeover from Automatic Top Feeding to using a J-Frame is now done within seconds. This makes it a more attractive to use feature for a variety of pre-formed workpieces. The Haeger J-Frame solution allows for insertion under flanges up to 1mm from the bending line.



Manual J-Frame in combination with 24" (610mm) throat depth.

J-Frame in combination with ABFT (Automatic Bottom Feed Tool). Unique in the industry is the Automatic Bottom Feeding of Nuts in combination with a J-Frame to maximize productivity and increase ergonomics for those workpieces requiring installation under return flanges.

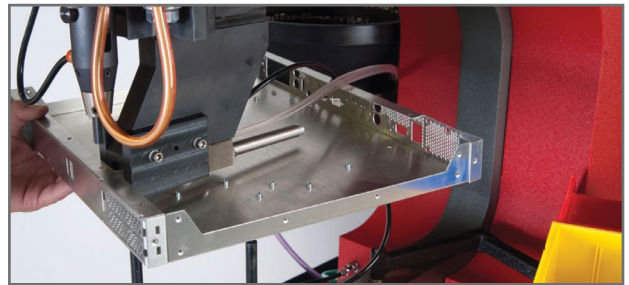

J-Frame in combination with ABFT (Automatic Bottom Feed Tool).

Automatic Tooling:

Upper Tools, Lower Tools and Shuttle Plates are compatible with previous Haeger machine models. The One-Piece Multi-module for the MAS-350 Autofeed System reduces total components per set from 5 to 4.

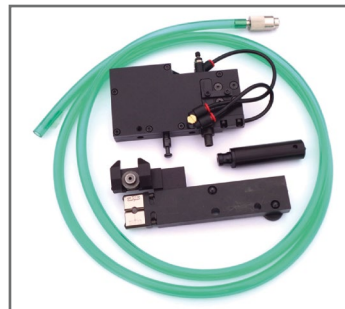

Shuttle Standoff Set.

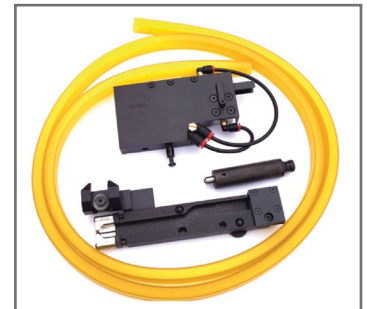

Shuttle Nut Set.

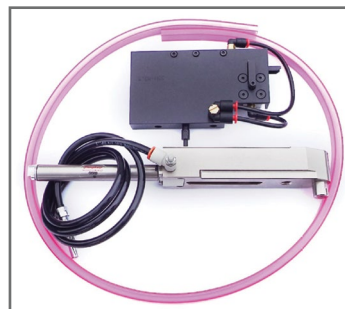

ABFT (Automatic Bottom Feed) Set.

Haeger® 824™ WindowTouch® 5e

Best Operator Ergonomics:

Operator control pendant can be adjusted in 6 directions, allowing for easy access and a great view of screen instructions while standing up or sitting down.



Operator control pendant adjustable in 6 directions.

Energy Saving:

New variable speed hydraulics reduce energy consumption up to 30% compared to conventional hydraulic systems.

Easier and Faster Programming:

The ALL NEW intuitive Insertion Logic® Software with Insertion Graphics and Integrated Statistic Process Control allows for more functionality while reducing programming time.

Insertion Logic® provides you with the recommended operating time for the part programmed and monitors and stores any corrected errors during the insertion process, allowing you to provide this data with your deliveries to your customers.

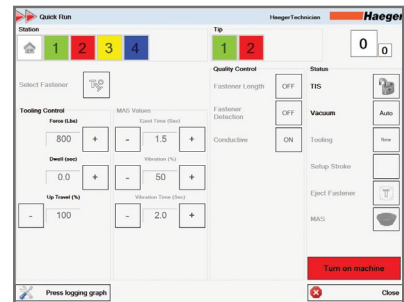

Easier and faster programming.



Dimensions:
 Length 59" / 1499 mm
 Wide 40" / 1016 mm
 Tall 94" / 2388 mm



94" / 2388 mm

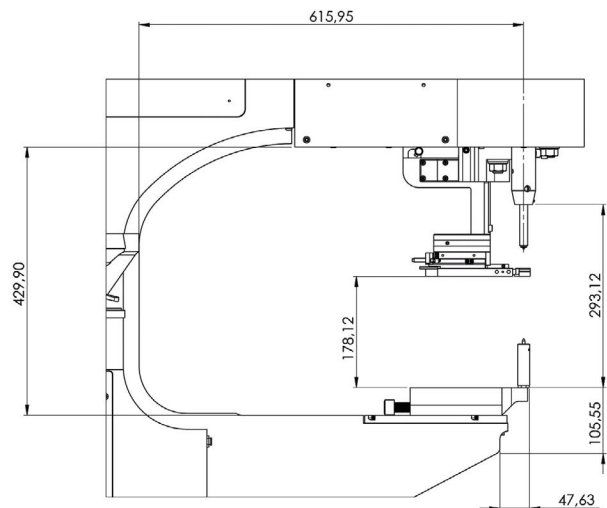
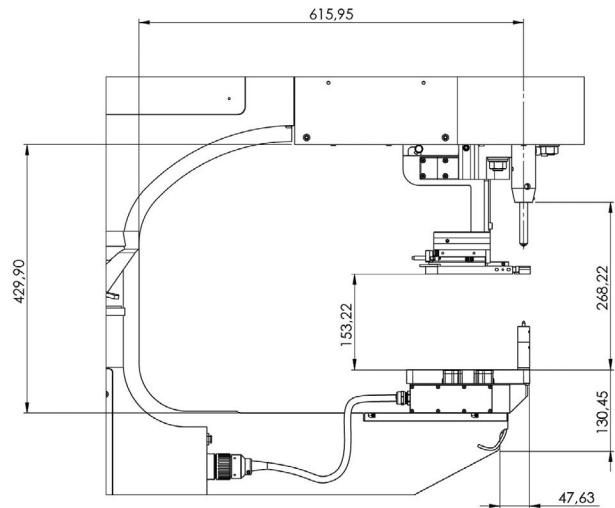

Specifications

Force Range	Adjustable 800 lbs. (3.6 kN) to 16,000 lbs. (72 kN)
Throat Depth	24" (610 mm)
Stroke Length	Adjustable 0 to 8.5" (0 to 220 mm)
Electrical	208 to 575 V 3 phase - 50 or 60 Hz
Motor	5 HP 3 Phase Low 16 A 208-240 V / High 9.6 A 380-480 V
Oil Tank Reservoir	22 gallons (83 liters)
Speed	up to 1,400 insertions per hour
Repeatability	+/- 2% of force setting
Weight	3,000 lbs. (1,361 kg)
Footprint	59"L x 40"W x 94"H (1499 mm x 1016 mm x 2388 mm)
Fastener Range	.256 to 1/2" (M2 to M12)

For more information on the 824™ WindowTouch® 5e and other Haeger® products, visit our website at www.haeger.com or contact your authorized Haeger® distributor.

Haeger® 824™ MSP 5e

The 824™ MSP 5e features:

- 8 ton (72kN) ram force and 24 inch (610mm) throat depth with adjustable ram retract position.
- Reliability/energy efficiency of a fully hydraulic machine.
- Haeger's patented safety system.
- Tooling Protection System and Batch Counter.

Positive Stop System

The Positive Stop System provides an easily adjustable method of precisely maintaining the stopping point of the machine cylinder. The system is particularly well suited for improving uniformity on soft, delicate work pieces. It is also effective when inserting small hardware. In addition to aluminum, the system also provides excellent insertion results on a wide variety of softer materials such as fiberglass, printed circuit boards, and many plastic or composite materials.

MAS 350 Modular Autofeed System (Optional)

The Modular Autofeed System can feed nuts, studs and standoffs in the size M2 till M10. The maximum length of the studs and standoffs is 30mm.



Modular Autofeed System.

Built-in TPS Controls

The Tooling Protection System (TPS) is designed to protect both the tooling and the workpiece from damage.

Tooling rack

Quick and easy access to tooling.

Turret Insertion System (Optional)

Install up to 4 different fasteners in 1 Single Part Handling (Option includes required Software for Single Part Handling Programming).

**ROBOT
COMMUNICATION
AVAILABLE**



Multi-shuttle tooling platform for nuts studs and standoffs.

Multi-Shuttle Tooling Platform for Nuts, Studs and Standoffs.

The Multi-Shuttle Platform provides a universal quick and easy tool change over between nuts, studs and standoffs – enabling 2-minute total tool changes without realignment. Changeover between Manual and Automatic Tooling setup is faster and easier.

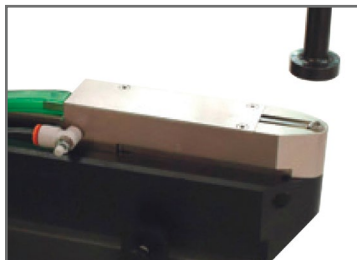

Automatic Bottom Feed Tooling (ABFT) for inserting nuts into at parts as well as into hard-to-reach holes. Such as those on the underside of a flange.

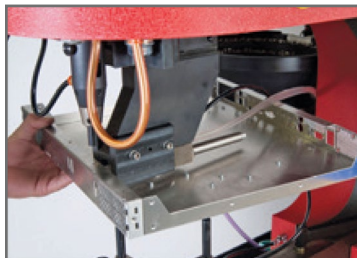

Automatic Bottom Feed J-Frame is used for those difficult to reach flanges.

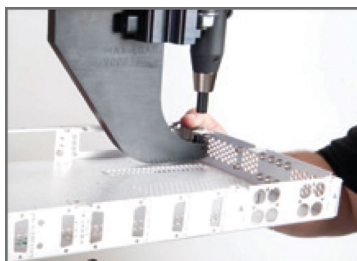

Manual tooling J-Frame is used for small boxes and short reverse flanges.

Specifications

Force Range	Adjustable 800 lbs. (3.6 kN) to 16,000 lbs. (72 kN) Optional 20,000 lbs. (90 kN) modification available
Throat Depth	24" (610 mm)
Stroke Length	Adjustable 0 to 8.5" (0 to 220 mm)
Electrical	208 to 575 V 3 phase - 50 or 60 Hz
Motor	5 HP 3 Phase Low 16 A 208-240 V / High 9.6 A 380-480 V
Oil Tank Reservoir	22 gallons (83 liters)
Speed	up to 1,400 insertions per hour
Repeatability	+/- 2% of force setting
Weight	2,800 lbs. (1,270 kg)
Footprint	59"L x 38"W x 94"H (1499 mm x 966 mm x 2388 mm)
Fastener Range	.256 to 1/2" (M2 to M12)

For more information on the 824™ MSPe and other Haeger® products, visit our website at www.haeger.com or contact your authorized Haeger® distributor.

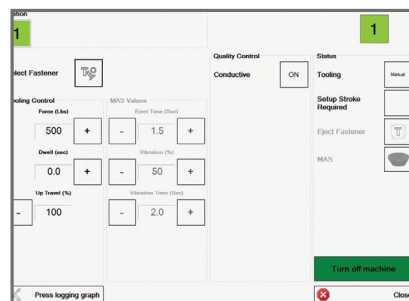

Single Station settings: Operators can set the Force, Dwell and Up Travel from this single station screen.

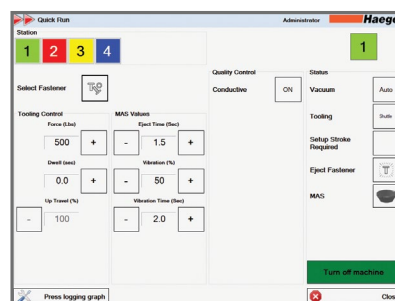

Multi-Station: Multi-Station is an option that allows the operator to insert more than one fastener in a program. Each station can be configured to have its own individual Force, Dwell Time and Up Travel.

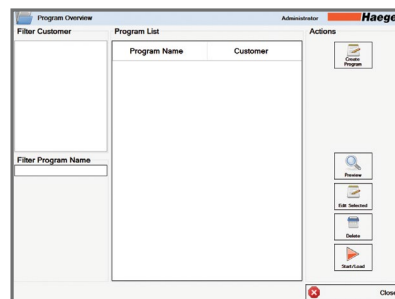

Programs: Up to 10,000 programs can be stored and loaded.

Haeger® 618™ MSP 5e

The 618™ MSP 5e features:

- 6 ton (53kN) ram force and 18 inch (450mm) throat depth with adjustable ram retract position.
- Reliability/energy efficiency of a fully hydraulic machine.
- Haeger's patented safety system.
- Tooling Protection System and Batch Counter.

Positive Stop System (Optional)

The Positive Stop System provides an easily adjustable method of precisely maintaining the stopping point of the machine cylinder. The system is particularly well suited for improving uniformity on soft, delicate work pieces. It is also effective when inserting small hardware. In addition to aluminum, the system also provides excellent insertion results on a wide variety of softer materials such as fiberglass, printed circuit boards, and many plastic or composite materials.

MAS 9 or MAS 350

Modular Autofeed System (Optional)

Customer has the choice to pick either feed system based on which type of auto tooling they want. The maximum stud and standoff lengths are up to 30mm.

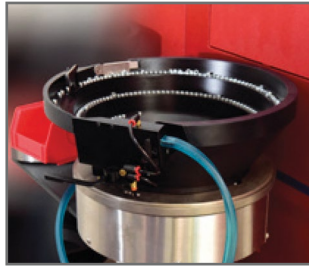

Modular Autofeed System.

Built-in TPS Controls

The Tooling Protection System (TPS) is designed to protect both the tooling and the workpiece from damage.

Tooling rack

Quick and easy access to tooling.



Multi-shuttle tooling platform for nuts studs and standoffs.

Multi-Shuttle Tooling Platform for Nuts, Studs and Standoffs.

The Multi-Shuttle Platform provides a universal quick and easy tool change over between nuts, studs and standoffs – enabling 2-minute total tool changes without realignment. Changeover between Manual and Automatic Tooling setup is faster and easier.

FASTENER INSERTION MACHINES

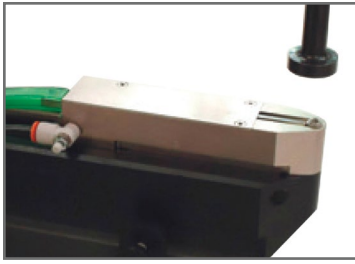

Automatic Bottom Feed Tooling (ABFT) for inserting nuts into at parts as well as into hard-to-reach holes. Such as those on the underside of a flange.

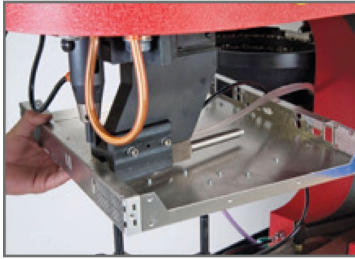

Automatic Bottom Feed J-Frame is used for those difficult to reach flanges.

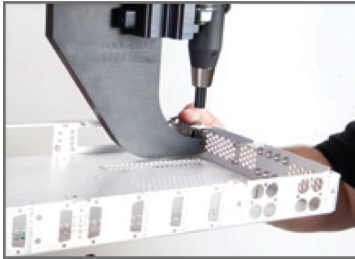

Manual tooling J-Frame is used for small boxes and short reverse flanges.

Specifications

Force Range Adjustable 500 lbs. (2.2 kN) to 12,000 lbs. (53 kN)

Repeatability +/- 2% of force setting

Throat Depth 18" (450 mm)

Stroke Length Adjustable 0 to 8.0" (0 to 200 mm)

Adjustable up stroke 3/8" - 6" (10 - 150 mm)

Oil Tank Reservoir 10 gallons (39 liters)

Hydraulic pump motor 2 HP 3 Phase Low 9 A 208-240 V / High 3.7 A 380-480 V

Electrical 200 to 575 V 3 phase - 50 or 60 Hz

Weight 1600 lbs. (726 kg)

Footprint 44"L x 66"W x 92"H (1143 mm x 864 mm x 2388 mm)

Fastener Range .256 to 5/16" (M2 to M8)

For more information on the 618™ MSPe and other Haeger® products, visit our website at www.haeger.com or contact your authorized Haeger® distributor.

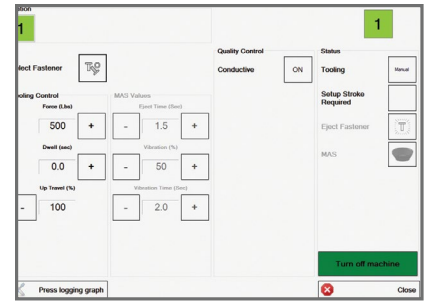

Single Station settings: Operators can set the Force, Dwell and Up Travel from this single station screen.

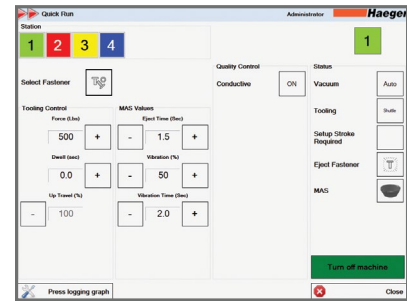

Multi-Station: Multi-Station is an option that allows the operator to insert more than one fastener in a program. Each station can be configured to have its own individual Force, Dwell Time and Up Travel.

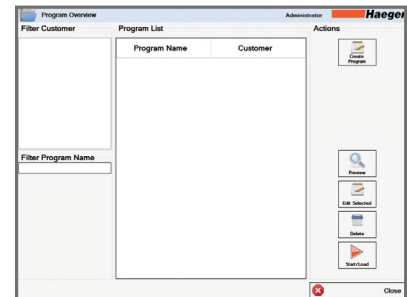

Programs: Up to 10,000 programs can be stored and loaded.

PEMSERTER® Series 4® Pneumatic Machine

- 6 tons of installation force.
- Large 18" (45.7cm) throat depth.
- Totally pneumatic providing consistency, simple operation and short cycle time for increased productivity.
- Requires shop air only.



Features and benefits

- Insertion force adjustable from 400 to 12,000 lbs. (1.8 to 53.4 kN).
- Installs self-clinching fasteners in sizes #0 to 3/8" and M2 to M10 in steel and up to 1/2" (M12) in aluminum or circuit boards.
- Integral point-of-operation safety.
- The Optical Sensor Indicator (OSI) is a user-friendly visual aid that makes setting up the safety quick and easy.
- Adjustable positive ram stop.
- Large parts tray with dividers.
- Rapid tooling changeover, perfect for short production runs.
- Laser pointer, stroke counter, and lockable cabinet for tools and accessories storage.

Optional anvil holders

Optional anvil holders and tooling can be easily installed on all new and existing PEMSERTER® Series 4® machine. When a workpiece flange and fastener location prohibits the use of standard tooling, the use of top or bottom mount, reverse flange anvil holders will often solve the installation problem.

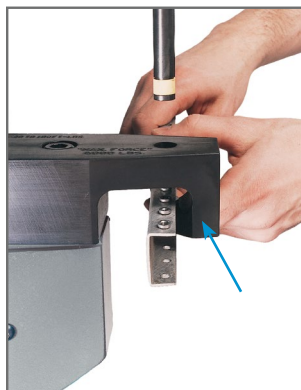

Bottom Mount Reverse Flange Anvil Holder.



Top Mount Reverse Flange Anvil Holder includes punch and anvil.



Optional QX4™ manual tooling

The PEMSERTER® QX4™ manual Turret Tool System provides an efficient method to quickly change between four different anvil tools. The one-handed operation of this tool allows an operator to install four different types and/or sizes of fasteners with one set-up. The QX4™ Turret Tool System can be easily installed on all new and existing PEMSERTER® Series 4® machine.

- Lower installed cost. Four different fasteners installed with one machine set-up.
- Increased productivity. Set-up time reduced. Turret is easily rotated by hand and positively locks in place.
- Reduced risk of missing a fastener or damaging work-piece. Each position is color-coded with matching color coded parts trays.

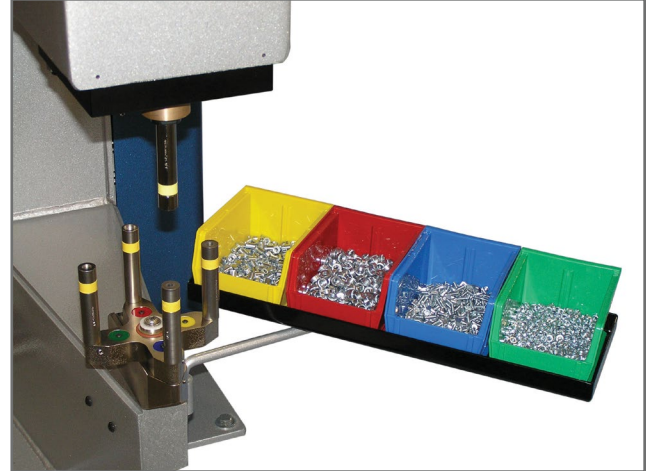

Optional QX4™ manual tooling.

Specifications

Ram Force	400 to 12,000 lbs. (1.8 to 53.4 kN)
Control System	Pneumatic Logic
Pressure System Type	Pneumatic / Lever
Air Requirements*	90 to 100 PSI (6 to 7 BAR) 1/2" (12mm) dia. minimum line flow
Throat Depth	18" (45.7cm)
Height (on cabinet)	66" (167.6cm)
Width (of machine)	17" (43.2cm)
Weight	Machine - 570 lbs. / 259 kg With Cabinet - 819 lbs. / 372 kg
Cabinet Dimensions	29" L x 26" W x 30" H (74cm L x 66cm W x 76cm H)

*1 psi = 0.07 bar. 1 bar = 14.5 psi.

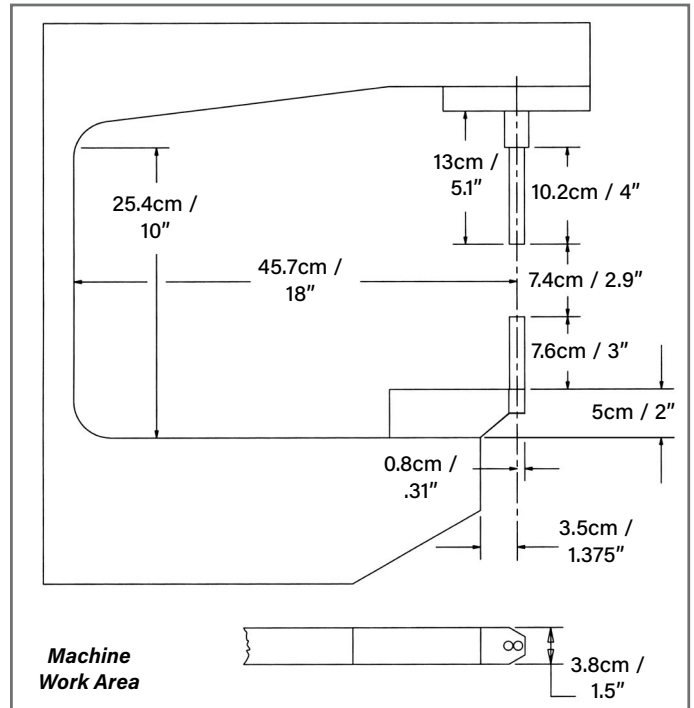

PEMSERTER® Series P3® Portable Pneumatic Hand Tool

The PEMSERTER® Series P3® fastener installation tool is a portable power hand tool weighing only 10 lbs (4.6 kg) that can develop a squeezing force of 5,000 lbs. (22.2 kN).

With the PEMSERTER Series P3 tool, you can easily install PEM® self-clinching nuts and studs in unified or metric sizes. The unified tool kit contains punches and anvils to install nuts and studs up to 0.5" in length ranging from #2-56 thru #10-32 thread sizes. The metric tool kit contains punches and anvils to install S™, CLS™ and CLA™ nuts ranging from M2 thru M5 thread sizes and FH™, FHS™ and FHA™ studs up to 12mm in length ranging from M2.5 thru M5 thread sizes.

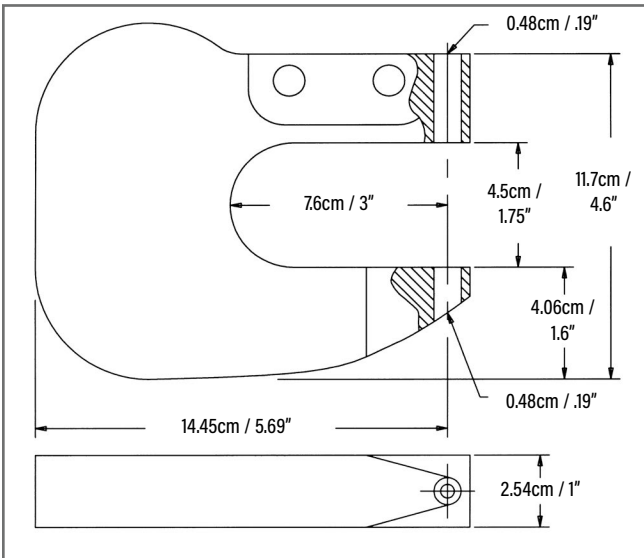

Specifications

Squeezing Force	5,000 lbs. (22.2 kN)
Pressure System Type	Pneumatic
Air Requirements*	90 to 100 PSI (6 to 7 BAR) 1/2" (12mm) dia. minimum line flow
Throat Depth	3" (7.6cm)
Length	16" (40.6cm)
Yoke Depth	6.2" (15.8 cm)
Weight	10 lbs. (4.6 kg)

*1 psi = 0.07 bar. 1 bar = 14.5 psi.

Features and benefits

- Pneumatic power for consistency and simple operation. Requires shop air only.
- Trigger controlled safety.
- Snap-in tooling changeover.
- Tool includes metric or unified tooling.
- Can be bench-mounted. Back side of yoke has two predrilled and tapped holes for bench mounting. Mounting bracket hardware included.

PEMSERTER® MICROMATE® Hand Tool

The PEMSERTER® MICRO-MATE® tool is a versatile hand tool weighing only 2.75 lbs. (1.25 kg) that can develop a squeezing force of 2,500 lbs. (1,134 kg).

Tool kit contains one hand tool, one flat punch, seven punches and dies, one punch adapter bushing, one edge-depth guide, five fastener anvils and a storage case. The unified kit installs nut sizes #2-56 to #10-32 and the metric kit installs nut sizes M2 to M5.



Features and benefits

- Equipped with punches and dies to punch fastener mounting holes in metal sheets.
- Changes to flat punch and recessed anvil to easily install unified or metric self-clinching nuts.
- Ideal for prototype shops or short production runs.

Specifications

Squeezing Force	2,500 lbs. (1,134 kg)
Throat Depth	1.75" (4.5 cm)
Weight	2.75 lbs. (1.25 kg)

For best overall performance PEM® fasteners must be installed using a parallel acting, controlled squeezing force. With proper installation the integrity of the assembly is ensured. Haeger® and PEMSERTER® installation machines are engineered and ideally suited for this specific purpose. The diverse family of fastener-insertion machines offered by PennEngineering ranges from basic handheld tools to the most technologically advanced systems available in the industry.

Having introduced the world's first self-clinching fastener in 1942, PennEngineering remains the sole manufacturer of genuine PEM® brand fasteners and the global leader in hardware and equipment solutions for thin-sheet attachment challenges.

PEM® self-clinching fasteners can be easily installed in just 3 easy steps:

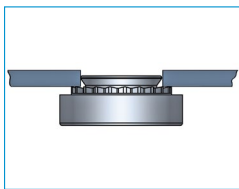

1. Place the fastener into the anvil hole and place the mounting hole (preferably the punch side) over the shank of the fastener.

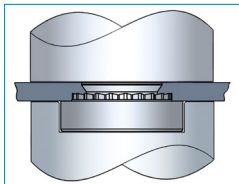

2. With installation punch and anvil surfaces parallel, apply squeezing force until the head of the nut comes in contact with the sheet material.

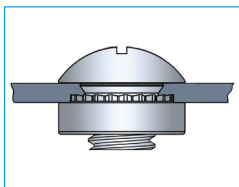

3. Install the mating piece from the side opposite the head of the fastener.

Additional notes . . .

1. Mounting holes may be punched or drilled; they should not be chamfered or have broken edges in excess of .005"/.127 mm. Hole tolerances of +.003, -.000/+0.08 mm must generally be held. The fastener should be installed on the punch side if the sheet is .09"/2.29 mm or thicker because of the piercing break-to-die diameter. In all cases, the manufacturer's recommended "minimum centerline of hole to edge of sheet" distance should be observed. No deburring or countersinking is required.
2. Installation typically results in a flush surface on one side of the panel.
3. When installing, the most important criterion is that the fastener must be squeezed into place with any parallel acting force.
4. Because the installation equipment generates no excess noise or pollution, the fasteners can be installed anywhere in the production process. No special facilities, ventilation equipment, or safety procedures are required.
5. When installed using the recommended squeezing force (depending on the size of the fastener and hardness of the sheet metal), there is little or no distortion of the sheet or damage to the finished surface. Fasteners generally should be installed after plating, finishing or anodizing.
6. Sheet material must be softer than the fastener. If the fastener is not hard enough, it will deform (crush) instead of cold flowing the sheet material.



All PEM® products meet our stringent quality standards. If you require additional industry or other specific [quality certifications](#), special procedures and/or part numbers are required. Please contact your local sales office or representative for further information.

Regulatory [compliance information](#) is available in Technical Support section of our website. Specifications subject to change without notice. See our website for the most current version of this bulletin.

PennEngineering®



North America: Oakdale, CA USA • Tel: +1-209-848-4000 • 800-878-4343 • Sales: sales@haeger.com • Service: service@haeger.com

Europe: The Netherlands • Tel: +31 541 530 230 • Sales: europesales@haeger.com • Service: europeservice@haeger.com

China: Sales and Service • Tel: +86 152 2121 0215 • E-mail: axue@haeger.com

Asia Pacific: Sales and Service • Tel: +65 6 745 0660 • E-mail: michaelquek@pemnet.com

www.haeger.com • www.pemnet.com