

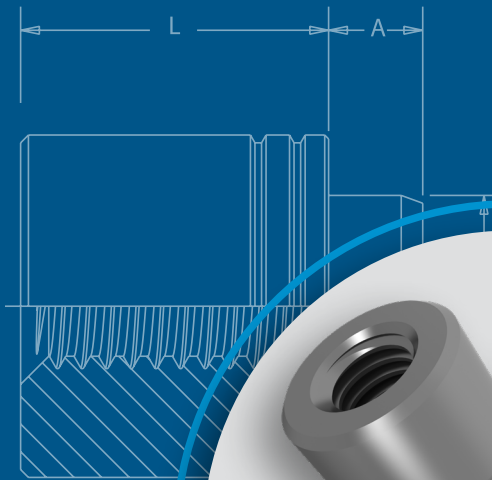

**K<sup>TM</sup>**

# FASTENERS FOR USE WITH PC BOARDS

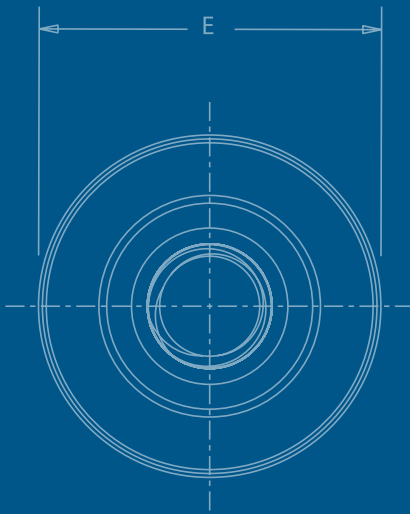

PEM® brand fasteners that utilize, surface-mount, broaching and flaring technology for use with PC boards.

No matter how sophisticated or advanced, electronic components must be attached reliably and securely if they are to deliver optimum performance. We offer several fastener products for use with PC boards to satisfy component-to-board, board-to-board, and board-to-chassis attachment needs.

**ReelFast® surface mount fasteners** mount on PC boards in the same manner and at the same time as other surface mount components prior to the automated reflow solder process. The fasteners simply become another board component. This alleviates concerns about potential damage to PC boards due to improper secondary installation operations. The fasteners are provided on tape and reel compatible with existing SMT automated installation equipment. The benefits of using ReelFast® SMT fasteners are: faster assembly; reduced scrap; reduced handling; and reduced risk of board damage.

**Broaching fasteners** can also offer practical alternatives to “loose” hardware. A broaching fastener is a knurled-shank fastening device that can be pressed into a hole to provide a permanent, strong, threaded or unthreaded attachment point in PC boards. They can also be used in aluminum, acrylic, casting and polycarbonate components. Specially formed axial grooves around the shank of the fastener “broach” or cut into the material, creating a firm, interference-type fit resistant to rotation. In PC boards, broaching fasteners are recommended for use in non-plated holes.

**Broach/flare-mount standoffs** (KFB3™) offer a combined broach/flare feature for even greater pullout performance in PC board materials.

Fastener drawings and models are available at [www.pemnet.com](http://www.pemnet.com). Custom sizes are available on special order. [Contact us](#) for more information.

## Nuts And Spacers/Standoffs

**SMTBSO™** - ReelFast® surface mount fasteners with internal blind-hole threads - [PAGE 4](#)



New

**SMTSO™/SMTSOB™** — ReelFast® surface mount nuts and standoffs are available threaded and unthreaded — [PAGE 5](#)



**SMTSS™** — ReelFast® SNAP-TOP® standoffs feature a spring action to hold PC board securely without screws or threaded hardware — [PAGE 6](#)



**SMTSK™** — ReelFast® KEYHOLE® standoffs eliminate the need for attaching screws — [PAGE 7](#)



**KF2™/KFS2™** — Broaching nuts, internally threaded for mounting on PC boards — [PAGE 8](#)



**KFE™/KFSE™** — Broaching standoffs, threaded or unthreaded for stacking or spacing — [PAGE 9](#)



**KFB3™** — Broach/flare-mount standoffs with greater pullout performance — [PAGE 10](#)



**KSSB™** — Broaching, SNAP-TOP® standoffs feature a spring action to hold PC board securely without screws or threaded hardware — [PAGE 11](#)



## Captive Panel Screws

**SMTPF LSM™** — ReelFast® surface mount spring-loaded captive panel screws — [PAGE 12](#)



**SMTPF™** — ReelFast® surface mount captive panel screws — [PAGE 13](#)



**PFK™** - Broaching panel fastener assemblies for mounting on PC boards — [PAGE 14](#)



## Studs

**KFH™** — Threaded broaching studs for use as solderable connectors or as permanently mounted studs on PC boards — [PAGE 15](#)



## Right Angle Fasteners

**SMTRA™** — ReelFast® R'ANGLE® surface mount fasteners provide strong re-usable threads at right angles to PC boards — [PAGE 16](#)



## Sheet Joining Fasteners

**SFK™** — SpotFast® clinch/broach mount fasteners for joining metal to PCB/plastic panels — [PAGE 17](#)



## Material and Finish Specifications

— [PAGE 18](#)

## Installation

— [PAGE 19-22](#)

## Performance Data

— [PAGE 23-25](#)

## Other fasteners for use with PC boards

— [PAGE 26](#)

Quick Reference Chart

PEM® Fastener	Page No.	Mounting Types				Primary Use							
		Broach	Broach/Flare	Surface Mount	Clinch/Broach	Nut	Spacer/Standoff	Snap Attachment	Stud	Captive Screw	Color Coding	Right Angle Attachment	Sheet to Sheet Joining
SMTBSO	4			▪		▪	▪						
SMTSO/SMTSOB	5			▪		▪	▪						
SMTSS	6			▪			▪	▪					
SMTSK	7			▪			▪						
KF2/KFS2	8	▪				▪							
KFE/KFSE	9	▪					▪						
KFB3	10		▪				▪						
KSSB	11	▪					▪	▪					
SMTPLSM	12			▪						▪			
SMTPF	13			▪						▪	▪		
PFK	14	▪								▪			
KFH	15	▪							▪				
SMTRA	16			▪								▪	
SFK	17				▪								▪

PEM® Trademarks

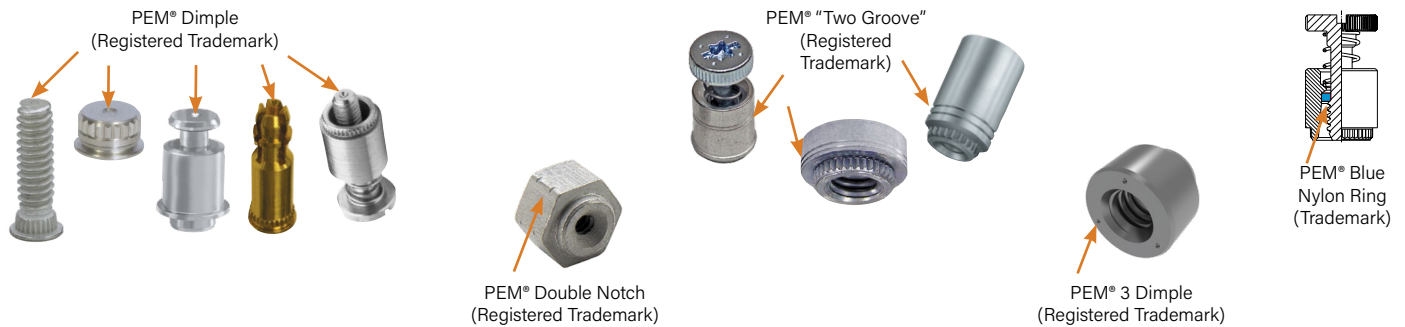

To be sure that you are getting genuine PEM® brand fasteners, look for the unique PEM® product markings and identifiers.



Fastener drawings and models are available at [www.pemnet.com](http://www.pemnet.com)

Custom sizes are available on special order. [Contact us](#) for more information.

## SMTBSO™ ReelFast® Surface Mount Fasteners

- Internal blind-hole threads securely mounts onto PC Board - less risk of damage to PC Board during assembly
- Allows for copper traces to run under the fastener which better utilizes space on the board
- Enhanced PC Board performance due to cut out of the fastener that allows for localized heat up of the area in contact with the solder

New

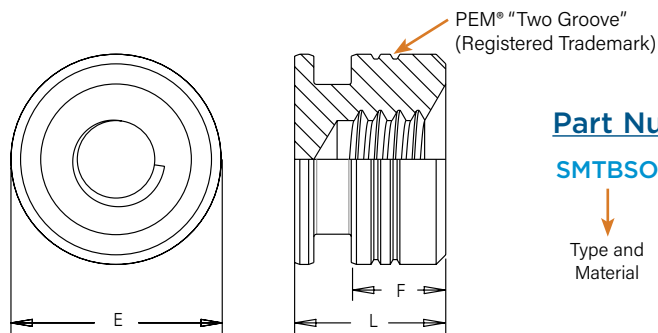
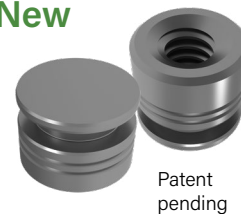

### Part Number Designation

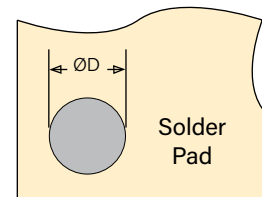
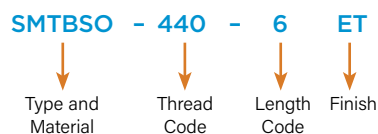

All dimensions are in inches.

Unified	Thread Size	Type	Thread Code	Length Code "L" ±.005 (Length code in 32nds of an inch)	E ±.005	ØD Min. Solder Pad	F Min.
		.112-40 (#4-40)	SMTBSO	440	.187 6	.219	.244

All dimensions are in millimeters.

Metric	Thread Size	Type	Thread Code	Length Code "L" ±0.13 (Length code in millimeters)	E ±0.13	ØD Min. Solder Pad	F Min.
		M3 x 0.5	SMTBSO	M3	4	5.56	6.2

### Number of Parts per Reel

Part Number	Number of Parts per Reel
SMTBSO-440-6ET	900
SMTBSO-M3-4ET	1000

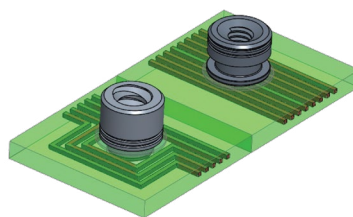

The SMTBSO™ fastener does not require a through hole allowing for copper traces to run under the fastener which better utilizes space on the board.

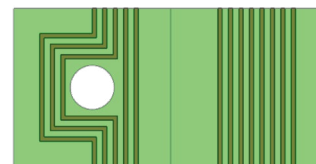

PC Board with through hole.      PC Board without through hole.

## SMTSO™/SMTSOB™ Reelfast® Surface Mount Nuts And Spacers/Standoffs

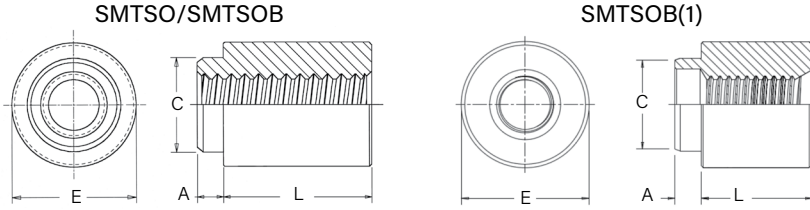

Thread/thru hole sizes 2-56, 4-40, 6-32, 8-32, 116, 143, M2, M2.5, M3, M3.5, M4, 3.1, 3.6, and 4.2

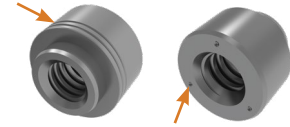

PEM® SMTSO and SMTSOB standoffs may be marked with either our "Two Groove" or "3 Dimple" registered trademarks.

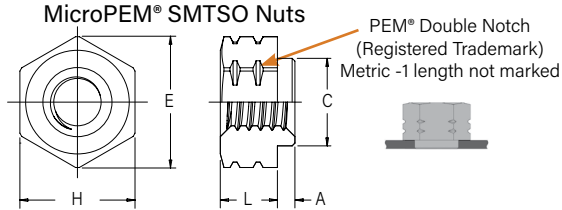

Thread sizes 080, S1, S1.2, S1.4 and M1.6

### Part Number Designation

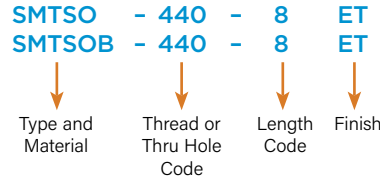

### Stencil Masking Examples

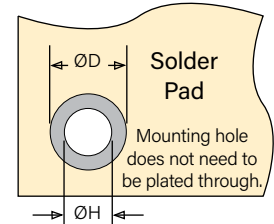
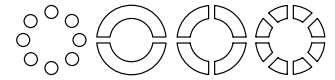

**NOTE:** Standoffs are available on special order without a pilot that do not require a thru hole for installation. Contact [techsupport@pemnet.com](mailto:techsupport@pemnet.com) for more information.

All dimensions are in inches.

Unified	Thread Size	Thru Hole +0.04 -0.03	Type		Thread or Thru Hole Code	Length Code "L" ±0.05 (Length code in 32nds of an inch)				Min. Sheet Thickness	A Max.	C Max.	E		H Nom.	ØH Hole Size In Sheet +0.03 -0.00	ØD Min. Solder Pad
			Fastener Material			.062	.125	.250	.375				Ref.	±0.05			
			Steel	Brass													
	.060-80 (#0-80)	-	SMTSO	-	080	2	4	-	-	.020	.019	.095	.144	.125	.098	.165	
	.086-56 (#2-56)	-	SMTSO	SMTSOB	256	2	4	8 <sup>(1)</sup>	12 <sup>(1)</sup>	.060	.060	.142	.219	-	.147	.244	
	.112-40 (#4-40)	-	SMTSO	SMTSOB	440	2	4	8 <sup>(1)</sup>	12 <sup>(1)</sup>	.060	.060	.161	.219	-	.166	.244	
	.138-32 (#6-32)	-	SMTSO	SMTSOB	632	2	4	8 <sup>(1)</sup>	12 <sup>(1)</sup>	.060	.060	.208	.281	-	.213	.306	
	.164-32 (#8-32)	-	SMTSO	SMTSOB	832	2	4	8 <sup>(1)</sup>	12 <sup>(1)</sup>	.060	.060	.245	.344	-	.250	.369	
	-	.116	SMTSO	SMTSOB	116	2	4	8	12	.060	.060	.161	.219	-	.166	.244	
	-	.143	SMTSO	SMTSOB	143	2	4	8	12	.060	.060	.208	.281	-	.213	.306	

All dimensions are in millimeters.

Metric	Thread Size x Pitch	Thru Hole +0.10 -0.08	Type		Thread or Thru Hole Code	Length Code "L" ±0.13 (Length code in millimeters)						Min. Sheet Thickness	A Max.	C Max.	E		H Nom.	ØH Hole Size In Sheet +0.08	ØD Min. Solder Pad	
			Fastener Material			1	2	3	4	6	8				10	Ref.				±0.13
			Steel	Brass																
	S1	-	SMTSO	-	M1	1	2	3	-	-	-	0.5	0.48	2.41	3.66	-	3.18	2.5	4.19	
	S1.2	-	SMTSO	-	M1.2	1	2	3	-	-	-	0.5	0.48	2.41	3.66	-	3.18	2.5	4.19	
	S1.4	-	SMTSO	-	M1.4	1	2	3	-	-	-	0.5	0.48	2.41	3.66	-	3.18	2.5	4.19	
	M1.6 x 0.35	-	SMTSO	-	M1.6	1	2	3	-	-	-	0.5	0.48	2.41	3.66	-	3.18	2.5	4.19	
	M2 x 0.4	-	SMTSO	SMTSOB	M2	-	2	3	4 <sup>(1)</sup>	6 <sup>(1)</sup>	8 <sup>(1)</sup>	10 <sup>(1)</sup>	1.53	1.53	3.6	-	5.56	-	3.73	6.2
	M2.5 x 0.45	-	SMTSO	SMTSOB	M2.5	-	2	3	4 <sup>(1)</sup>	6 <sup>(1)</sup>	8 <sup>(1)</sup>	10 <sup>(1)</sup>	1.53	1.53	4.09	-	5.56	-	4.22	6.2
	M3 x 0.5	-	SMTSO	SMTSOB	M3	-	2	3	4 <sup>(1)</sup>	6 <sup>(1)</sup>	8 <sup>(1)</sup>	10 <sup>(1)</sup>	1.53	1.53	4.09	-	5.56	-	4.22	6.2
	M3.5 x 0.6	-	SMTSO	SMTSOB	M3.5	-	2	3	4 <sup>(1)</sup>	6 <sup>(1)</sup>	8 <sup>(1)</sup>	10 <sup>(1)</sup>	1.53	1.53	5.28	-	7.14	-	5.41	7.77
	M4 x 0.7	-	SMTSO	SMTSOB	M4	-	2	3	4	6 <sup>(1)</sup>	8 <sup>(1)</sup>	10 <sup>(1)</sup>	1.53	1.53	6.22	-	8.74	-	6.35	9.37
	-	3.1	SMTSO	SMTSOB	3.1	-	2	3	4	6	8	10	1.53	1.53	4.09	-	5.56	-	4.22	6.2
	-	3.6	SMTSO	SMTSOB	3.6	-	2	3	4	6	8	10	1.53	1.53	5.28	-	7.14	-	5.41	7.77
	-	4.2	SMTSO	SMTSOB	4.2	-	2	3	4	6	8	10	1.53	1.53	6.22	-	8.74	-	6.35	9.37

(1) SMTSOB fasteners with this length code have a shank counterbore.

### Number Of Parts Per Reel / Pitch (MM) For Each Size

Thread/Thru-Hole Size	Length Code							
	1	2	3	4	6	8	10	12
080	-	3500 / 8	-	2000 / 8	-	-	-	-
256, 440, 632, 116, 143	-	1500 / 12	-	1000 / 12	-	650 / 12	-	300 / 16
832	-	1100 / 16	-	800 / 16	-	500 / 16	-	300 / 16
M1, M1.2, M1.4, M1.6	3500 / 8	2500 / 8	2000 / 8	-	-	-	-	-
M2, M2.5, M3, M3.5, 3.1, 3.6	-	1500 / 12	1000 / 12	900 / 12	650 / 12	375 / 16	300 / 16	-
M4, 4.2	-	1100 / 16	800 / 16	675 / 16	500 / 16	375 / 16	300 / 16	-



A polyimide patch is supplied to allow for reliable vacuum pickup. Fasteners are also available without a patch which may provide a lower cost alternative, depending on your installation methods/requirements.

Packaged on 330 mm recyclable reels. Tape width is 24 mm. Reels conform to EIA-481.

### SMTSS™ Reelfast® Snap-Top® Standoffs

**NOTE:** REELFAST® SNAP-TOP® SMTSS™ standoffs are for on-only applications. For removal applications, mounting hole A can be increased to reduce removal force.

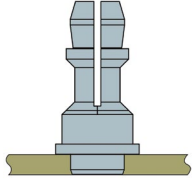
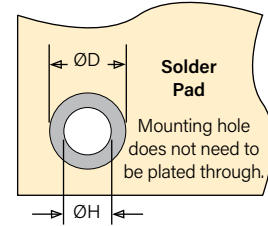
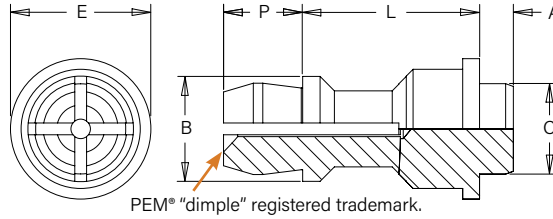

#### Part Number Designation

**SMTSS S - 156 - 12 ET**

↓   ↓   ↓   ↓   ↓

Type   Material   Top Board Mounting Hole A Diameter Code   Length Code   Finish

#### Stencil Masking Examples

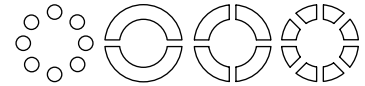

All dimensions are in inches.

Unified	Top Board Mounting Hole A Diameter Code	Type and Material	Length Code "L" ±.005 (Length Code in 32nds of an inch)		Min. Sheet Thickness	A Max.	C Max.	E ±.005	B ±.005	P ±.005	ØH Hole Size in Sheet +.003 -.000	ØD Min. Solder Pad
			.250	.375								
	156	SMTSSS	8	12	.060	.060	.161	.250	.188	.141	.166	.276

All dimensions are in millimeters.

Metric	Top Board Mounting Hole A Diameter Code	Type and Material	Length Code "L" ±0.13 (Length Code in millimeters)			Min. Sheet Thickness	A Max.	C Max.	E ±0.13	B ±0.13	P ±0.13	ØH Hole Size in Sheet +0.08	ØD Min. Solder Pad
			6	8	10								
	4MM	SMTSSS	6	8	10	1.53	1.53	4.09	6.35	4.8	3.58	4.22	7

#### Number Of Parts Per Reel

Type, Material and Size	Length Code / Number of Parts per Reel		
SMTSSS-156	-8 / 280	-12 / 220	
SMTSSS-4MM	-6 / 300	-8 / 250	-10 / 200



Packaged on 330 mm recyclable reels. Tape width is 24 mm. Supplied with polyimide patch for vacuum pick up. Reels conform to EIA-481.

#### SMTSS™ Application Data

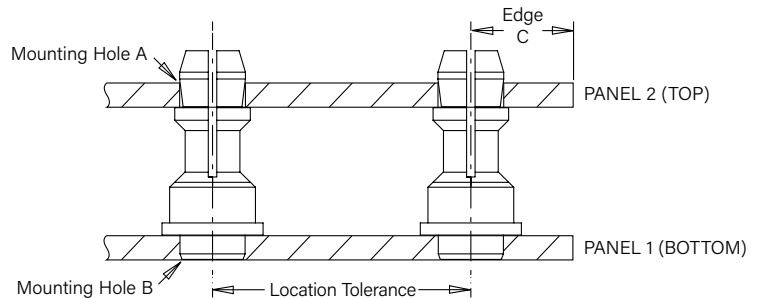

All dimensions are in inches.

Unified	Type	Panel 1					Panel 2				
		Hardness Max.	Bottom Mounting Hole B +.003 -.000	Panel Material	Thickness Min.	Location Tolerance	Hardness Max.	Top Mounting Hole A +.003 -.000	Panel Material	Thickness Range	Edge Distance C Min.
	SMTSS	No Limit	.166	PC board	.060	±.005	No Limit	.156	PC board or Metal	.040 - .070	.100

All dimensions are in millimeters.

Metric	Type	Panel 1					Panel 2				
		Hardness Max.	Bottom Mounting Hole B +0.08	Panel Material	Thickness Min.	Location Tolerance	Hardness Max.	Top Mounting Hole A +0.08	Panel Material	Thickness Range	Edge Distance C Min.
	SMTSS	No Limit	4.22	PC board	1.53	±0.13	No Limit	4	PC board or Metal	1 - 1.8	2.54

## SMTSK™ Reelfast® Keyhole® Standoffs

- Unique barrel design allows for quick attachment and detachment.
- Makes horizontal or vertical component mounting possible.

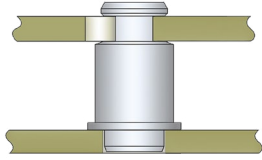
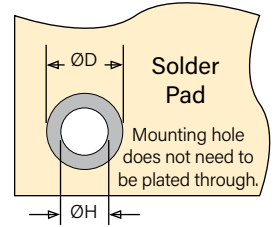
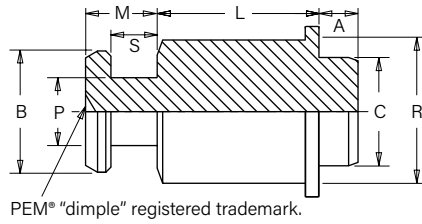

### Part Number Designation

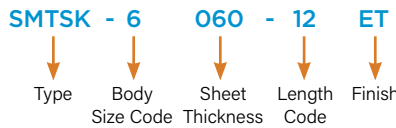

### Stencil Masking Examples

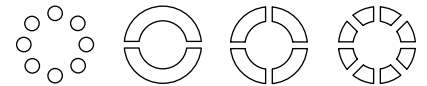

All dimensions are in inches.

Unified	Type	Body Size - Sheet Code	Length "L" ± .005 (Length Code in 32nds of an inch)			Min. Sheet Thickness	A Max.	C Max.	E ±.005	B ±.003	P ±.003	R Max.	S ±.003	M Max.	ØH Hole Size in Sheet +.003 -.000	ØD Min. Solder Pad
			.125	.250	.375											
SMTSK	6060		4	8	12	.060	.060	.161	.250	.177	.099	.212	.068	.108	.166	.276

All dimensions are in millimeters.

Metric	Type	Body Size - Sheet Code	Length "L" ± 0.13 (Length Code in millimeters)					Min. Sheet Thickness	A Max.	C Max.	E ±0.13	B ±0.08	P ±0.08	R Max.	S ±0.08	M Max.	ØH Hole Size in Sheet +0.08	ØD Min. Solder Pad
			3	4	6	8	10											
SMTSK	61.5		3	4	6	8	10	1.53	1.53	4.09	6.35	4.5	2.51	5.39	1.73	2.75	4.22	7

### Number Of Parts Per Reel

Part Number	Length Code "L"		
	.125	.250	.375
SMTSK-6060	4	8	12
	630	440	230

Part Number	Length Code "L"				
	3	4	6	8	10
SMTSK-61.5	640	540	440	260	220

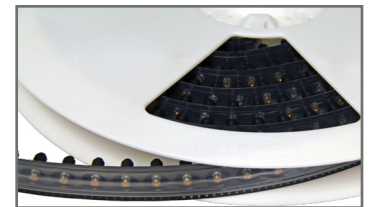

Packaged on 13" recyclable reels. Tape width is 24mm and 16mm. Pitch is 16mm and 12mm. Reels conform to EIA-481.

### Application Data

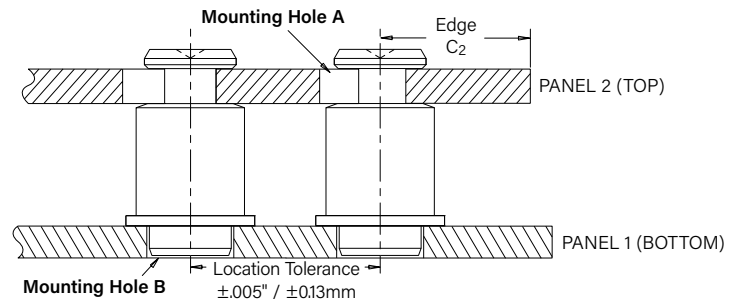
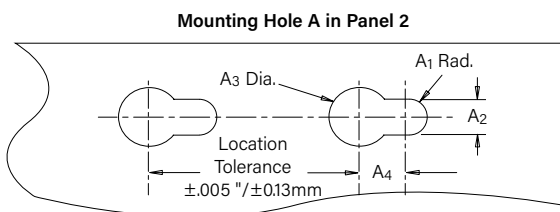

All dimensions are in inches.

Unified	Type	Hardness Max.	Panel 1				Panel 2						
			Bottom Mounting Hole B +.003 -.000	Panel Material	Thickness Min.	Location Tolerance	Top Mounting Hole A				Panel Material	Thickness Range	Edge Distance C2 Min.
							A1 Nom.	A2 ±.003	A3 ±.003	A4 Min.			
SMTSK		No Limit	.166	PC board	.060	±.005	.059	.118	.197	.148	ANY	.057 - .064	.160

All dimensions are in millimeters.

Metric	Type	Hardness Max.	Panel 1				Panel 2						
			Bottom Mounting Hole B +0.08	Panel Material	Thickness Min.	Location Tolerance	Top Mounting Hole A				Panel Material	Thickness Range	Edge Distance C2 Min.
							A1 Nom.	A2 ±0.08	A3 ±0.08	A4 Min.			
SMTSK		No Limit	4.22	PC board	1.53	±0.13	1.5	3	5	3.75	ANY	1.45 - 1.62	4.1

**Note About Plated And Unplated Mounting Holes For Broaching Fasteners**

Broaching and broach/flare types are designed for unplated mounting hole applications. If used in plated mounting holes, the stresses involved can damage the plating, push out the plating entirely, or break any traces inside the board that might be connected to the plated hole. When installing into non-plated mounting holes there may even be issues with delamination, measeling or crazing in some instances.

Increasing the mounting hole size +.005" to +.008" / +0.13 mm to +0.2 mm may relieve these conditions. If increasing the mounting hole does not correct the issue then we recommend our surface-mount type fasteners.

It is always recommended that you try the fasteners in your specific application before full production begins. We are happy to provide samples for this purpose.

General recommendations for "Keep Out" areas are the same as our "Min. Distance Hole C/L to Edge" dimensions stated in the dimensional charts of our bulletin.

**KF2™/KFS2™ Broaching Nuts**

- Can be used in aluminum, acrylic, casting and polycarbonate components

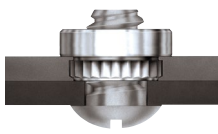

**Part Number Designation**

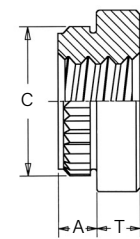
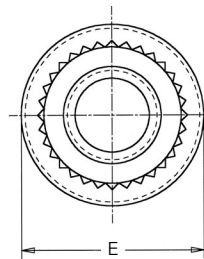
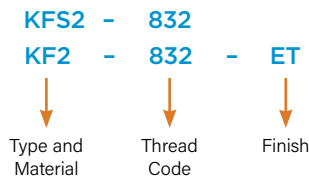

All dimensions are in inches.

	Thread Size	Type		Thread Code	A (Shank) Max.	Min. Sheet Thickness	Hole Size In Sheet +.003 -.000	C ±.003	E ±.005	T ±.005	Min. Dist. Hole C/L to Edge (1)
		Carbon Steel	Stainless Steel								
<b>Unified</b>	.086-56 (#2-56)	KF2	KFS2	256	.060	.060	.147	.165	.219	.065	0.16
	.112-40 (#4-40)	KF2	KFS2	440	.060	.060	.166	.184	.219	.065	0.17
	.138-32 (#6-32)	KF2	KFS2	632	.060	.060	.213	.231	.281	.065	0.22
	.164-32 (#8-32)	KF2	KFS2	832	.060	.060	.250	.268	.344	.096	0.25
	.190-32 (#10-32)	KF2	KFS2	032	.060	.060	.272	.290	.375	.127	0.28

All dimensions are in millimeters.

	Thread Size x Pitch	Type		Thread Code	A (Shank) Max.	Min. Sheet Thickness	Hole Size In Sheet +0.08	C ±0.08	E ±0.13	T ±0.13	Min. Dist. Hole C/L to Edge (1)
		Carbon Steel	Stainless Steel								
<b>Metric</b>	M2 x 0.4	KF2	KFS2	M2	1.53	1.53	3.73	4.19	5.56	1.5	4.2
	M2.5 x 0.45	KF2	KFS2	M2.5	1.53	1.53	4.22	4.68	5.56	1.5	4.4
	M3 x 0.5	KF2	KFS2	M3	1.53	1.53	4.22	4.68	5.56	1.5	4.4
	M4 x 0.7	KF2	KFS2	M4	1.53	1.53	6.4	6.81	8.74	2	6.4
	M5 x 0.8	KF2	KFS2	M5	1.53	1.53	6.9	7.37	9.53	3	7.1

(1) For more information on proximity to bends and distance to other clinch hardware, see [PEM® Tech Sheet C/L To Edge](#).



## KFE™/KFSE™ Broaching Standoffs

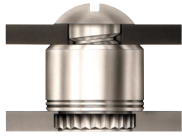

### Part Number Designation

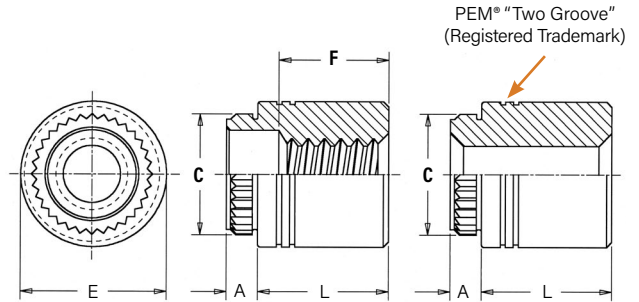
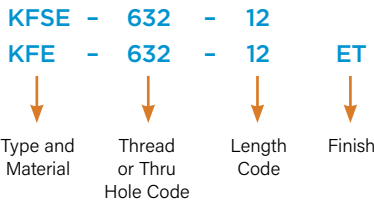

All dimensions are in inches.

Unified	Thread Size	Thru Hole +.004 -.003	Type		Thread or Thru Hole Code	Length "L" ±.005 (Length Code is in 32nds of an inch)								A (Shank) Max.	Min. Sheet Thickness	Hole Size In Sheet +.003 -.000	C ±.003	E ±.005	Min. Dist. Hole C/L to Edge (2)
			Carbon Steel	Stainless Steel		.125	.250	.375	.500	.625	(1) .750	(1) .875	(1) 1.00						
	.112-40 (#4-40)	—	KFE	KFSE	440	4	8	12	16	20	24	—	—	.060	.060	.166	.184	.219	.17
	.138-32 (#6-32)	—	KFE	KFSE	632	4	8	12	16	20	24	28	32	.060	.060	.213	.231	.281	.22
	—	.116	KFE	KFSE	116	4	8	12	16	20	24	—	—	.060	.060	.166	.184	.219	.17
	—	.143	KFE	KFSE	143	4	8	12	16	20	24	28	32	.060	.060	.213	.231	.281	.22
"F" Minimum Thread Length (Where Applicable)						Full			.375 ± .016			.375 Blind							

All dimensions are in millimeters.

Metric	Thread Size x Pitch	Thru Hole +.010 -.008	Type		Thread or Thru Hole Code	Length "L" ±0.13 (Length Code is in millimeters)								A (Shank) Max.	Min. Sheet Thickness	Hole Size In Sheet +0.08	C ±0.08	E ±0.13	Min. Dist. Hole C/L to Edge (2)
			Carbon Steel	Stainless Steel		3	4	6	8	10	12	14	16						
	M3 x 0.5	—	KFE	KFSE	M3	3	4	6	8	10	12	14	16	1.53	1.53	4.22	4.68	5.56	4.4
	—	3.6	KFE	KFSE	3.6	3	4	6	8	10	12	14	16	1.53	1.53	5.41	5.87	7.14	5.5
	—	4.2	KFE	KFSE	4.2	3	4	6	8	10	12	14	16	1.53	1.53	6.4	6.81	8.74	7.1
"F" Minimum Thread Length (Where Applicable)						Full			9.5										

(1) Blind at shank end with .375" minimum thread length from head end.

(2) For more information on proximity to bends and distance to other clinch hardware, see [PEM® Tech Sheet C/L To Edge](#).

KFB3™ Broach/Flare-Mount Standoffs

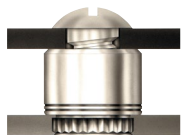

Part Number Designation

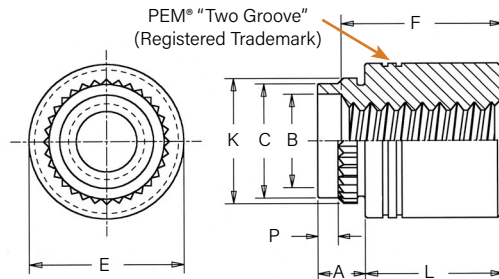
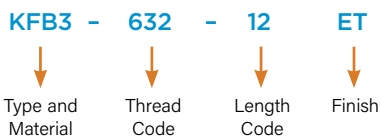

All dimensions are in inches.

Unified	Thread Size	Type	Thread Code	Length Code "L" ±.005 (Length code in 32nds of an inch)										A (shank) Max.	Sheet Thickness	Hole Size in Sheet +.005 -.001	B ±.003	C Max.	E ±.005	K ±.003	P ±.010	Min. Dist. Hole C/L to Edge (2)
				.062	.125	.187	.250	.312	.375	.500	.625	.750 (1)	1.00 (1)									
	.112-40 (#4-40)	KFB3	440	2	4	6	8	10	12	16	20	—	—	.09	.050-.065	.166	.122	.165	.219	.179	.040	.17
	.138-32 (#6-32)	KFB3	632	2	4	6	8	10	12	16	20	24	32	.09	.050-.065	.213	.171	.212	.280	.226	.040	.22
	.190-32 (#10-32)	KFB3	032	2	4	6	8	10	12	16	20	24	32	.09	.050-.065	.272	.128	.271	.375	.285	.040	.275
	.250-32 (1/4-20)	KFB3	0420	2	4	6	8	10	12	16	20	24	32	.09	.050-.065	.335	.183	.331	.437	.348	.040	.335
"F" Min. Thread Length (Where Applicable)				Full									.375 Blind									

All dimensions are in millimeters.

Metric	Thread Size x Pitch	Type	Thread Code	Length Code "L" ±0.13 (Length code in millimeters)										A (shank) Max.	Sheet Thickness	Hole Size in Sheet +0.13 -0.03	B ±0.08	C Max.	E ±0.13	K ±0.08	P ±0.25	Min. Dist. Hole C/L to Edge (2)
				2	3	4	6	8	10	12	14	16										
	M3 x 0.5	KFB3	M3	2	3	4	6	8	10	12	14	16	2.29	1.27-1.65	4.22	3.23	4.2	5.56	4.55	1	4.33	
	M4 x 0.7	KFB3	M4	2	3	4	6	8	10	12	14	16	2.29	1.27-1.65	6.4	5.23	6.33	8.74	6.68	1	6.36	
	M5 x 0.8	KFB3	M5	2	3	4	6	8	10	12	14	16	2.29	1.27-1.65	6.9	5.8	6.86	9.53	7.23	1	7	
	M6 x 1	KFB3	M6	2	3	4	6	8	10	12	14	16	2.29	1.27-1.65	8.5	7.2	8.4	11.1	8.83	1	8.5	
"F" Minimum Thread Length (Where Applicable)				Full									9.5									

- (1) Blind at shank end with .375" minimum thread length from head end.
- (2) For more information on proximity to bends and distance to other clinch hardware, see [PEM® Tech Sheet C/L To Edge](#).

### KSSB™ Broaching Snap-Top® Standoffs

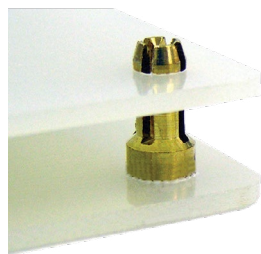

#### Part Number Designation

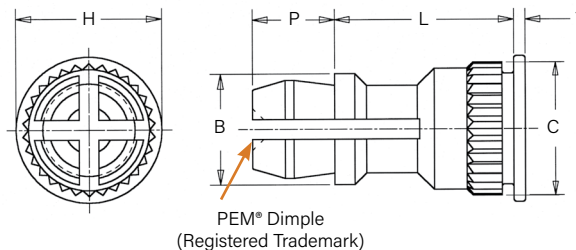
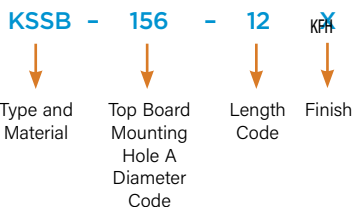

All dimensions are in inches.

Unified	Type	Top Board Mounting Hole A Diameter Code	Length "L" ±.005 (Length Code is in 32nds of an inch)										B ±.005	C ±.003	H ±.005	P ±.005	T ±.005
			.250	.312	.375	.437	.500	.562	.625	.750	.875	1.00					
	KSSB	156	8	10	12	14	16	18	20	24	28	32	.188	.226	.250	.141	.020

All dimensions are in millimeters.

Metric	Type	Top Board Mounting Hole A Diameter Code	Length "L" ±0.13 (Length Code is in millimeters)										B ±0.13	C ±0.08	H ±0.13	P ±0.13	T ±0.13
			8	10	12	14	16	18	20	22	25						
	KSSB	4MM	8	10	12	14	16	18	20	22	25	4.8	5.74	6.35	3.58	0.51	

### KSSB™ Application Data

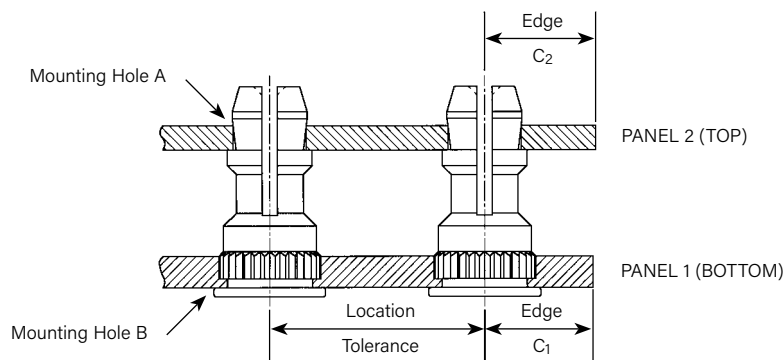

All dimensions are in inches.

Unified	Type	Panel 1						Panel 2				
		Hardness Max. (1)	Bottom Mounting Hole B +.003 -.000	Panel Material	Thickness Min.	Edge Distance C <sub>1</sub> Min.	Location Tolerance	Hardness Max.	Top Mounting Hole A +.003 -.000	Panel Material	Thickness Range (2)	Edge Distance C <sub>2</sub> Min.
	KSSB	HRB 65 / HB 116	.213	PC board	.050	.220	±.005	No Limit	.156	PC board or Metal	.040 - .070	.100

All dimensions are in millimeters.

Metric	Type	Panel 1						Panel 2				
		Hardness Max. (1)	Bottom Mounting Hole B +0.08	Panel Material	Thickness Min.	Edge Distance C <sub>1</sub> Min.	Location Tolerance	Hardness Max.	Top Mounting Hole A +0.08	Panel Material	Thickness Range (2)	Edge Distance C <sub>2</sub> Min.
	KSSB	HRB 65 / HB 116	5.41	PC board	1.27	5.59	±0.13	No Limit	4	PC board or Metal	1 - 1.8	2.54

(1) HRB - Hardness Rockwell "B" Scale, HB - Hardness Brinell.  
 (2) Available for thicker boards on special order.

## SMTPF LSM™ ReelFast® Surface Mount Captive Panel Screws

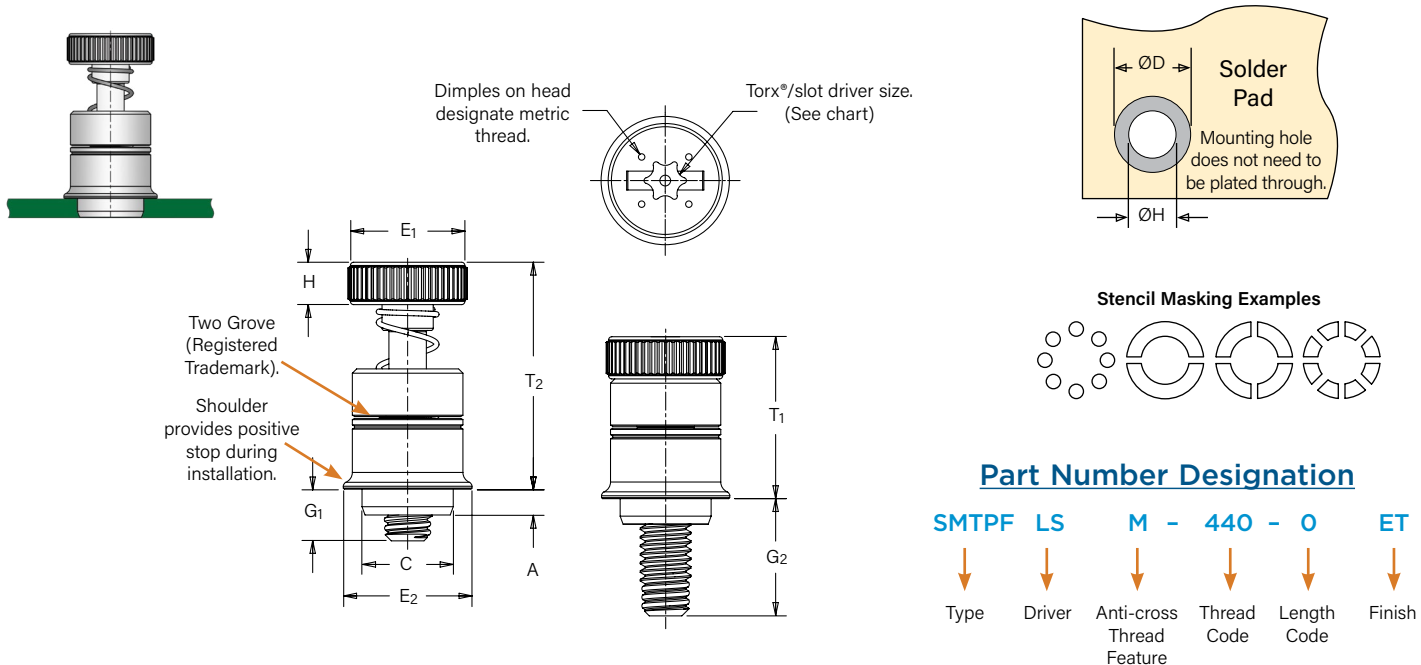

All dimensions are in inches.

Unified	Thread Size	Type	Thread Code	Screw Length Code	A (Shank) Max.	Min. Sheet Thickness	C Max.	E1 ±.010	E2 Nom	G1 ±.025	G2 ±.025	H ±.010	T1 Nom.	T2 Nom.	ØK Hole Size in Sheet +.003 -.000	ØD Min. Solder Pad	Driver Size
	.112-40 (#4-40)	SMTPF LSM	440	0	.063	.063	.215	.280	.300	.040	.210	.100	.38	.55	.220	.340	T15
				1													
.138-32 (#6-32)	SMTPF LSM	632	0	.063	.063	.247	.310	.320	.040	.240	.100	.42	.62	.252	.400	T15	
			1														

All dimensions are in millimeters.

Metric	Thread Size	Type	Thread Code	Screw Length Code	A (Shank) Max.	Min. Sheet Thickness	C Max.	E1 ±0.25	E2 Nom	G1 ±0.64	G2 ±0.64	H ±0.25	T1 Nom.	T2 Nom.	ØK Hole Size in Sheet +0.08	ØD Min. Solder Pad	Driver Size
	M3 x 0.5	SMTPF LSM	M3	0	1.6	1.6	5.46	7	76	1	5.3	2.5	9.6	14	5.6	8.6	T15
				1													
M3.5 x 0.6	SMTPF LSM	M3.5	0	1.6	1.6	6.27	79	813	1	6.1	2.5	10.7	15.7	6.4	10.2	T15	
			1														2.5

### Number Of Parts Per Reel

Thread Size	Parts Per Reel
440	200
632	150
M3	200
M3.5	150



Packaged on 330 mm recyclable reels. Tape width is 24 mm. Supplied with polyimide patch for vacuum pick up. Reels conform to EIA-481.

# SMPF™ ReelFast® Surface Mount Captive Panel Screws

Patented.

## When Assembled

Spring action of plastic "fingers" holds screw in retracted position.

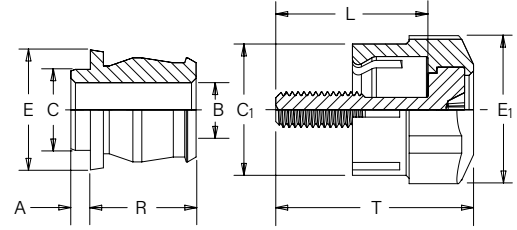
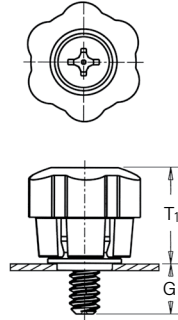
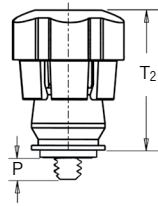
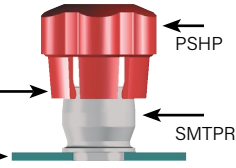

All dimensions are in inches.

Unified	Thread Size	Screw Part Number			Retainer Part Number	Assembly Dimensions					Screw Dimensions				Retainer Dimensions					
		Type	Thread Code	Screw Length Code		G ± .025	P ± .025	T <sub>1</sub> Nom.	T <sub>2</sub> Nom.	Total Radial Float	C <sub>1</sub> ±.010	E <sub>1</sub> ±.010	L ±.015	T Nom.	A (Shank) Max.	Min. Sheet Thick.	B ±.003	C Max.	E Nom.	R ±.005
#4-40	.112-40	PSHP	440	0	SMPF-6-1	.188	.000	.478	.646	.015	.440	.542	.510	.663	.060	.060	.167	.249	.375	.325
				1		.248	.026						.570	.723						
#6-32	.138-32	PSHP	632	0	SMPF-6-1	.188	.000	.478	.646	.020	.440	.542	.510	.663	.060	.060	.167	.249	.375	.325
				1		.248	.026						.570	.723						

All dimensions are in millimeters.

Metric	Thread Size x Pitch	Screw Part Number			Retainer Part Number	Assembly Dimensions					Screw Dimensions				Retainer Dimensions					
		Type	Thread Code	Screw Length Code		G ± 0.64	P ± 0.64	T <sub>1</sub> Nom.	T <sub>2</sub> Nom.	Total Radial Float	C <sub>1</sub> ±0.25	E <sub>1</sub> ±0.25	L ±0.38	T Nom.	A (Shank) Max.	Min. Sheet Thick.	B ±0.08	C Max.	E Nom.	R ±0.13
M3 x 0.5	M3	PSHP	M3	0	SMPF-6-1	4.78	0	12.14	16.41	.38	11.18	13.77	12.95	16.84	1.53	1.53	4.24	6.33	9.53	8.26
				1		6.3	.66						14.48	18.36						
M3.5 x 0.6	M3.5	PSHP	M3.5	0	SMPF-6-1	4.78	0	12.14	16.41	.51	11.18	13.77	12.95	16.84	1.53	1.53	4.24	6.33	9.53	8.26
				1		6.3	.66						14.48	18.36						

**RETAINER** — Packaged on 330 mm recyclable reels of 400 pieces. Tape width is 24 mm. Supplied with Kapton® patch for vacuum pick up. Reels conform to EIA-481.

**SCREW** — Packaged in bags. Retainers and screws are sold separately.

## Part Number Designation For Screw

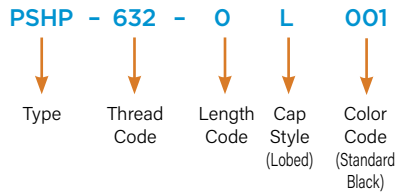

## Part Number Designation For Retainer

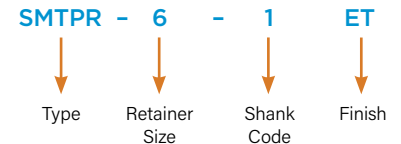

## Color Capabilities For Type PSHP Screw

The colors shown here (codes #002 thru #007) are non-stocked standards and available on special order. Since actual cap colors may vary slightly from those shown here, we recommend that you request samples for color verification. If you require a custom color or you need a "color matched" cap, please contact us.

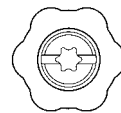

Available with Torx® recess on special order.

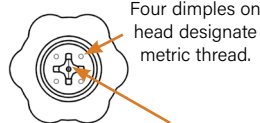

Four dimples on head designate metric thread.  
**Metal Phillips Recess**  
 #4-40 & M3 = #1  
 #6-32 & M3.5 = #2

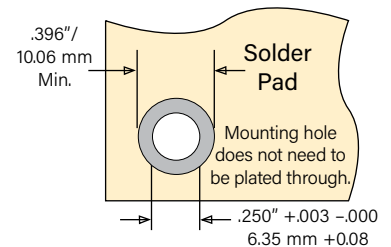

## Stencil Masking Examples



Non-flammable UL 94-V0 plastic caps are available on special order.

PFK™ Broaching Captive Panel Screws

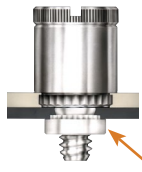

Shown here with self-clinching mating nut

Part Number Designation

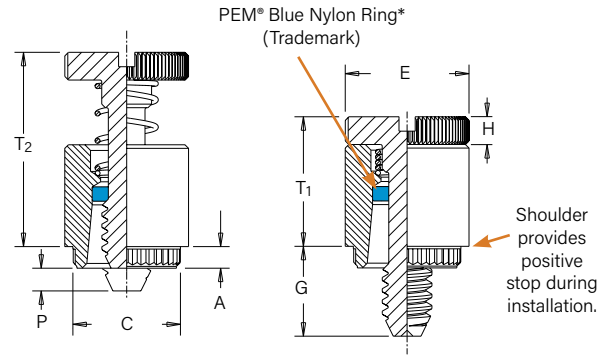
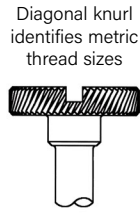
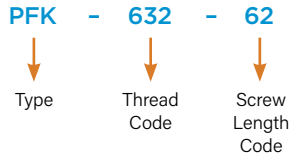

All dimensions are in inches.

Unified	Thread Size	Type	Thread Code	Screw Length Code	A (Shank) Max.	Min. Sheet Thickness	Hole Size In Sheet +.003 -.000	C ±.003	E ±.010	G ±.016	H ±.005	P ±.025	T <sub>1</sub> Max.	T <sub>2</sub> Nom.	Min. Dist. Hole C/L to Edge (1)
	.112-40 (#4-40)	PFK	440	40	.060	.060	.265	.283	.312	.250	.072	.000	.36	.54	.20
				62						.375		.125			
84				.500						.250					
.138-32 (#6-32)	PFK	632	40	.060	.060	.281	.299	.344	.250	.072	.000	.36	.54	.26	
			62						.375		.125				
			84						.500		.250				

All dimensions are in millimeters.

Metric	Thread Size x Pitch	Type	Thread Code	Screw Length Code	A (Shank) Max.	Min. Sheet Thickness	Hole Size In Sheet +0.08	C ±0.08	E ±0.25	G ±0.4	H ±0.13	P ±0.64	T <sub>1</sub> Max.	T <sub>2</sub> Nom.	Min. Dist. Hole C/L to Edge (1)
	M3 x 0.5	PFK	M3	40	1.53	1.53	6.73	7.19	7.92	6.4	1.83	0	9.14	13.72	5.08
				62						9.5		3.2			
84				12.7						6.4					

\*Retaining rings are plastic with normal 250°F / 120°C temperature limit.

(1) For more information on proximity to bends and distance to other clinch hardware, see [PEM® Tech Sheet C/L To Edge](#).

## KFH™ Broaching Studs

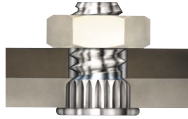

### Part Number Designation

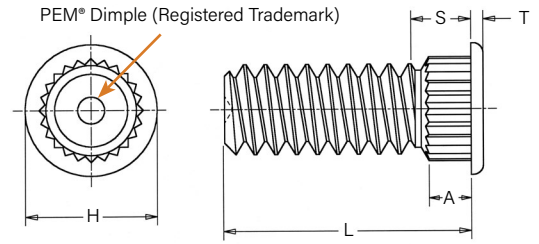
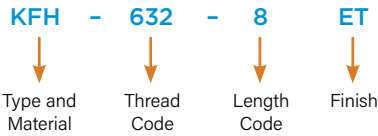

All dimensions are in inches.

Unified	Thread Size	Type	Thread Code	Length "L" ±.010 (Length Code is in 16ths of an inch)					A (Shank) Max.	Min. Sheet Thickness	Hole Size in Sheet +.003 -.000	Max. Hole Size in Attached Parts	H ±.010	S Max. (1)	T ±.005	Min. Dist. Hole C/L to Edge (2)	
				.250	.312	.375	.500	.625									.750
	.112-40 (#4-40)	KFH	440	4	5	6	8	10	12	.065	.060	.120	.145	.180	.09	.020	.15
	.138-32 (#6-32)	KFH	632	4	5	6	8	10	12	.065	.060	.140	.170	.200	.09	.020	.19
	.164-32 (#8-32)	KFH	832	4	5	6	8	10	12	.065	.060	.166	.195	.225	.09	.020	.20
	.190-32 (#10-32)	KFH	032	4	5	6	8	10	12	.065	.060	.189	.220	.250	.09	.020	.20

All dimensions are in millimeters.

Metric	Thread Size x Pitch	Type	Thread Code	Length "L" ±0.25 (Length Code is in millimeters)					A (Shank) Max.	Min. Sheet Thickness	Hole Size in Sheet +0.08	Max. Hole Size in Attached Parts	H ±0.25	S Max. (1)	T ±0.13	Min. Dist. Hole C/L to Edge (2)	
				6	8	10	12	15									18
	M3 x 0.5	KFH	M3	6	8	10	12	15	18	1.65	1.53	3	3.7	4.58	2.3	0.51	3.8
	M4 x 0.7	KFH	M4	6	8	10	12	15	18	1.65	1.53	4.2	4.8	5.74	2.3	0.51	5.1
	M5 x 0.8	KFH	M5	6	8	10	12	15	18	1.65	1.53	5	5.8	6.6	2.3	0.51	5.3

- (1) Threads are gaugeable to within 2 pitches of the "S" Max. dimension. A class 3B/5H maximum material commercial nut shall pass up to the "S" Max. dimension.
- (2) For more information on proximity to bends and distance to other clinch hardware, see [PEM® Tech Sheet C/L To Edge](#).

# SMTRA™ ReelFast® Surface Mount Right Angle (R'angle®) Fasteners

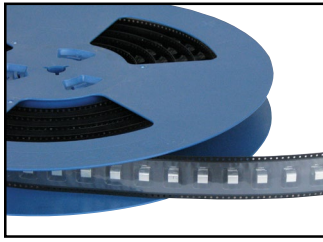

## Part Number Designation

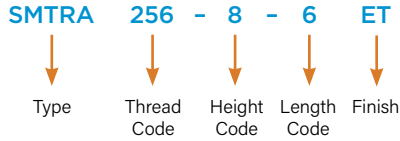

Patented.

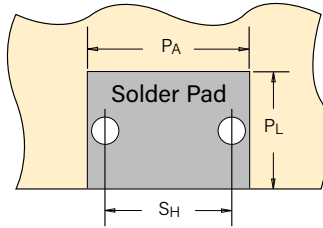

Solder pad can be flush to edge.  
Mounting holes do not need to be plated through.

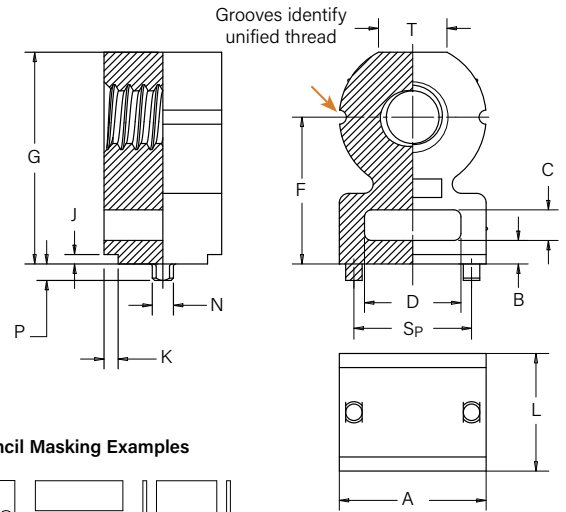

### Stencil Masking Examples



All dimensions are in inches.

Unified	Thread Size	Type	Thread Code	Height Code	Length Code	Length L ±.005	Min. Sheet Thickness	Hole Size In Sheet +.003 -.000	A ±.006	B ±.006	C ±.006	D ±.006	Height F ±.006	G ±.006	J Nom.	K Nom.	N Max.	P Max.	Sp ±.003	T Nom.
	.086-56 (#2-56)	SMTRA	256	8	6	.188	.040	.053	.218	.040	.060	.140	.250	.345	.020	.030	.048	.040	.157	.105
	.112-40 (#4-40)	SMTRA	440	9	6	.188	.040	.053	.250	.050	.065	.160	.281	.390	.020	.030	.048	.040	.188	.125
	.138-32 (#6-32)	SMTRA	632	10	8	.250	.040	.053	.312	.050	.065	.205	.312	.450	.020	.030	.048	.040	.250	.145
	.164-32 (#8-32)	SMTRA	832	12	9	.281	.040	.053	.375	.050	.075	.250	.375	.535	.020	.030	.048	.040	.312	.195

All dimensions are in millimeters.

Metric	Thread Size x Pitch	Type	Thread Code	Height Code	Length Code	Length L ±0.13	Min. Sheet Thickness	Hole Size In Sheet +0.08	A ±0.15	B ±0.15	C ±0.15	D ±0.15	Height F ±0.15	G ±0.15	J Nom.	K Nom.	N Max.	P Max.	Sp ±0.08	T Nom.
	M2 x 0.4	SMTRA	M2	6	5	5	1	1.35	5.5	1	1.5	3.5	6	8.4	0.5	0.75	1.22	1	4	2.65
	M2.5 x 0.45	SMTRA	M25	6	5	5	1	1.35	5.5	1	1.5	3.5	6	8.4	0.5	0.75	1.22	1	4	2.65
	M3 x 0.5	SMTRA	M3	7	5	5	1	1.35	6.35	1.25	1.65	4	7	9.75	0.5	0.75	1.22	1	4.75	3.2
	M4 x 0.7	SMTRA	M4	9	7	7	1	1.35	9.53	1.25	1.65	6.35	9	13.1	0.5	0.75	1.22	1	7.9	4.8

Unified	Thread Code	Pad Width PA Min.	Pad Length PL Min.	Hole Spacing SH ±.002	Hole Size In Sheet +.003 -.000
	256	.262	.171	.157	.053
	440	.294	.171	.188	.053
	632	.356	.233	.250	.053
	832	.419	.264	.312	.053

Metric	Thread Code	Pad Width PA Min.	Pad Length PL Min.	Hole Spacing SH ±0.05	Hole Size In Sheet +0.08
	M2	6.62	4.57	4	1.35
	M25	6.62	4.57	4	1.35
	M3	7.47	4.57	4.75	1.35
	M4	10.65	6.57	7.9	1.35

Part Number	Parts Per Reel	Pitch (mm)	Tape Width (mm)
SMTRA256-8-6	375	16	24
SMTRA440-9-6	300	16	24
SMTRA632-10-8	200	20	32
SMTRA832-12-9	200	20	32
SMTRAM2-6-5	375	16	24
SMTRAM25-6-5	375	16	24
SMTRAM3-7-5	300	16	24
SMTRAM4-9-7	200	20	32

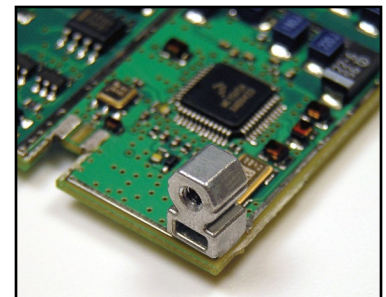



SFK™ SpotFast® Clinch/Broach Mount Fasteners

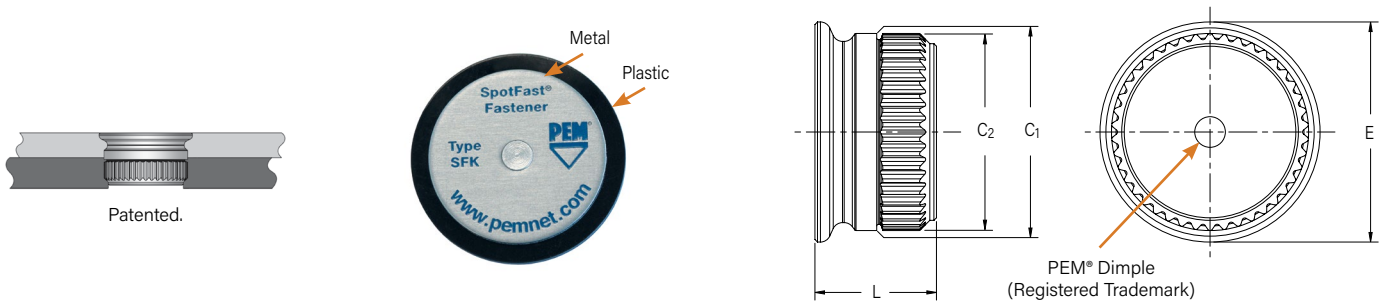

Type and Size	Thickness Code	Panel 1				Panel 2				C <sub>1</sub> Max.		C <sub>2</sub> ±0.08 mm / ±.003"		E Max.		L Max.		Min. Dist. Hole C/L to Edge (2)	
		Thickness ±0.08 mm / ±.003"		Mounting Hole +0.08 mm / +.003" - .000"		Thickness Min. (1)		Mounting Hole +0.08 mm / +.003" - .000"											
		mm	in.	mm	in.	mm	in.	mm	in.	mm	in.	mm	in.	mm	in.	mm	in.		
SFK-3	0.8	0.8	.031	3	.118	1.6	.063	2.5	.098	2.98	.117	2.9	.114	3.53	.139	2.31	.091	3	0.12
SFK-3	1.0	1	.039	3	.118	1.6	.063	2.5	.098	2.98	.117	2.9	.114	3.76	.148	2.51	.099	3	0.12
SFK-3	1.2	1.2	.047	3	.118	1.6	.063	2.5	.098	2.98	.117	2.9	.114	3.76	.148	2.72	.107	3	0.12
SFK-3	1.6	1.6	.063	3	.118	1.6	.063	2.5	.098	2.98	.117	2.9	.114	3.76	.148	3.12	.123	3	0.12
SFK-5	0.8	0.8	.031	5	.197	1.6	.063	4.5	.177	4.98	.196	4.9	.193	5.56	.219	2.31	.091	5.1	0.20
SFK-5	1.0	1	.039	5	.197	1.6	.063	4.5	.177	4.98	.196	4.9	.193	5.56	.219	2.51	.099	5.1	0.20
SFK-5	1.2	1.2	.047	5	.197	1.6	.063	4.5	.177	4.98	.196	4.9	.193	5.56	.219	2.72	.107	5.1	0.20
SFK-5	1.6	1.6	.063	5	.197	1.6	.063	4.5	.177	4.98	.196	4.9	.193	5.56	.219	3.12	.123	5.1	0.20

- (1) Fastener will provide flush application at minimum sheet thickness.
- (2) For more information on proximity to bends and distance to other clinch hardware, see [PEM® Tech Sheet C/L To Edge](#).



Can be used as a single flush-mounted pivot point. For more information, please contact [techsupport@pemnet.com](mailto:techsupport@pemnet.com)

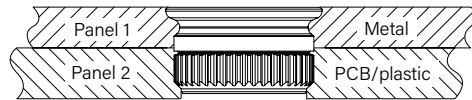

Type SFK joining metal to PCB/plastic.

Part Number Designation

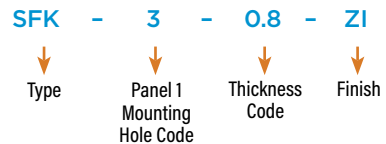

Material And Finish Specifications

Type	Threads (1)		Fastener Materials					Standard Finishes			Optional Finish		For Use in Sheet Hardness: (3)				
	Internal, ASME B1.1 2B/ ASME B1.13M 6H	External, ASME B1.1 2A/ ASME B1.13M 6g	Lead-Free Carbon Steel	300 Series Stainless Steel	CDA-510 Phosphor Bronze	Brass	Nylon, Temp. Limit 200° F/ 93° C	Passivated and/or Tested Per ASTM A380	Electro-Plated Tin ASTM B 545, Class B With Clear Preservative Coating, annealed (4)	No Finish	Electro-Plated Tin ASTM B 545, Class B With Clear Preservative Coating, annealed (4)	Black Nitride	HRB 70 / HB 125 or Less	HRB 65 / HB 116 or Less	HRB 60 / HB 107 or Less	HRB 55 / HB 96 or Less	Aluminum, Acrylic, Castings, Polycarbonate, and PC board
KF2	.	.	.	.	.	.	.	.	.	.	.	.	.	.	.	.	
KFS2	.	.	.	.	.	.	.	.	.	.	.	.	.	.	.	.	
KFE	.	.	.	.	.	.	.	.	.	.	.	.	.	.	.	.	
KFSE	.	.	.	.	.	.	.	.	.	.	.	.	.	.	.	.	
KFB3	.	.	.	.	.	.	.	.	.	.	.	.	.	.	.	.	
KSSB	.	.	.	.	.	.	.	.	.	.	.	.	.	.	.	.	
KFH	.	.	.	.	.	.	.	.	.	.	.	.	.	.	.	.	
PFK Retainer	.	.	.	.	.	.	.	.	.	.	.	.	.	.	.	.	
Screw	.	.	.	.	.	.	.	.	.	.	.	.	.	.	.	.	
Spring	.	.	.	.	.	.	.	.	.	.	.	.	.	.	.	.	
Retaining Ring	.	.	.	.	.	.	.	.	.	.	.	.	.	.	.	.	
Part Number Codes For Finishes							None	ET	X	ET	BN						

Type	Threads (1)		Fastener Materials					Standard Finishes (2)			For Use in Sheet Hardness: (3)	
	Miniature ISO 1501, 4H6	Internal, ASME B1.1 2B/ ASME B1.13M 6H	External, ASME B1.1 2A/ ASME B1.13M 6g	Lead-Free Carbon Steel	Hardened Carbon Steel	300 Series Stainless Steel	Brass	Zinc Diecast	Zinc Plated per ASTM B633, SC1 (5µm), Type III, Colorless	Electro-Plated Tin ASTM B 545, Class A With Clear Preservative Coating, annealed (4)	Bright Nickel Over Copper Flash	HRB 80 / HB 150 or less
SMTSO	S1 to S1.4	0-80 to 8-32/ M1.6 to M4	.	.	.	.	.	.	.	.	.	.
SMTSOB	.	.	.	.	.	.	.	.	.	.	.	.
SMTBSO	.	.	.	.	.	.	.	.	.	.	.	.
SMTRA	.	.	.	.	.	.	.	.	.	.	.	.
SMPFLSM	.	.	.	.	.	.	.	.	.	.	.	.
Retainer	.	.	.	.	.	.	.	.	.	.	.	.
Screw	.	.	.	.	.	.	.	.	.	.	.	.
Spring	.	.	.	.	.	.	.	.	.	.	.	.
PSHP (5)	.	.	.	.	.	.	.	.	.	.	.	.
SMTPR	.	.	.	.	.	.	.	.	.	.	.	.
SFK	.	.	.	.	.	.	.	.	.	.	.	.
SMTSSS	.	.	.	.	.	.	.	.	.	.	.	.
SMTSK	.	.	.	.	.	.	.	.	.	.	.	.
Part Number Codes For Finishes								ZI	ET	CN		

(1) For plated studs, Class 2A/6g, the maximum major and pitch diameter, after plating, may equal basic sizes and can be gauged to Class 3A/6h, per ASME B1.1 Section 7, Paragraph 2 and ASME B1.13M, Section 8, Paragraph 8.2.  
 (2) See PEM Technical Support section of our web site for related plating standards and specifications.  
 (3) HRB - Hardness Rockwell "B" Scale, HB - Hardness Brinell.  
 (4) Optimal solderability life noted on packaging.  
 (5) ABS cap on PSHP screw has a temperature limit of 200° F / 93° C.  
 (6) The tin deposit on type SMTSOB meets the requirements of ASTM B545, Class A and although the copper and nickel barrier layers used under the tin do not strictly comply with ASTM B545 thickness requirements they have proven effective at preventing zinc migration and providing the specified solderable shelf life.

## Installation

### KF2™/KFS2™/KFE™/KFSE™/PFK™ Fasteners

1. Prepare properly sized mounting hole in board.
2. Place fastener into the anvil hole and place the mounting hole over the shank of the fastener as shown in drawing.
3. With installation punch and anvil surfaces parallel, apply squeezing force until shoulder contacts the board.

### PEMSERTER® Installation Tooling (1)

Type	Thread Code	Anvil Part Number	Punch Part Number
KFE/KFSE	440/116 -4 to -8	975200846300	975200048
KFE/KFSE	440/116 -10 to -12	975200847300	
KFE/KFSE	440/116 -16 to -20	975200848300	
KFE/KFSE	440/116 -20 to -24	975200882300	
KFE/KFSE	M3 -3 to -6	975200846300	
KFE/KFSE	M3 -8 to -10	975200847300	
KFE/KFSE	M3 -12 to -14	975201222300	
KFE/KFSE	M3 -14 to -16	975200848300	
KFE/KFSE	632/143 -4 to -8	975200849300	
KFE/KFSE	632/143 -10 to -12	975200850300	
KFE/KFSE	632/143 -16 to -20	975200851300	
KFE/KFSE	632/143 -22 to -24	975200883300	
KFE/KFSE	632/143 -28 to -32	975200884300	
KFE/KFSE	3.6 -3 to -6	975200849300	975200048
KFE/KFSE	3.6 -8 to -10	975200850300	
KFE/KFSE	3.6 -12 to -16	975200851300	
KFE/KFSE	4.2 -2	975201216300	
KFE/KFSE	4.2 -3 to -6	975201217300	
KFE/KFSE	4.2 -8 to -10	975201218300	
KFE/KFSE	4.2 -12 to -14	975201220300	
KFE/KFSE	4.2 -14 to -16	975201219300	

### PEMSERTER® Installation Tooling (1)

Type	Thread Code	Anvil Part Number	Punch Part Number
PFK	440/M3	975200026	975200060
PFK	632	975200027	975200061

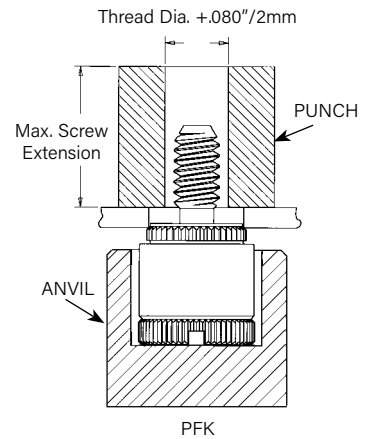

### PEMSERTER® Installation Tooling (1)

Type	Thread Code	Anvil Part Number	Punch Part Number
KF2/KFS2	080	8015899	975200048
KF2/KFS2	256/440/M2/M2.5/M3	975200904300	
KF2/KFS2	632/M3.5	975200035	
KF2/KFS2	832/M4	975200037	
KF2/KFS2	032/M5	975200905300	

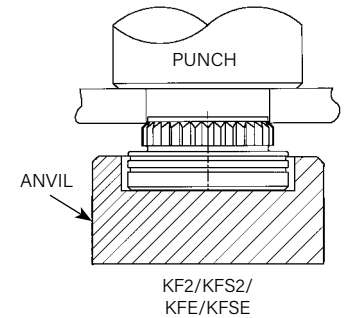

(1) [Click here](#) for a quote on Haeger® custom installation tooling.

### KSSB™/KFH™ Fasteners

1. Prepare properly sized mounting hole in board.
2. Place fastener into mounting hole as shown.
3. With installation punch and anvil surfaces parallel, apply squeezing force until head contacts the board.

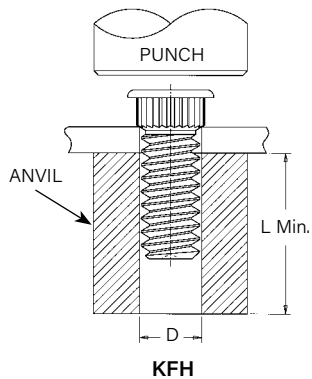

### PEMSERTER® Installation Tooling (1)

Part Number	D +.003\" - .000\"	Punch Part No.	Anvil Part No.*
KFH-440-L	.113\"	975200048	970200006300
KFH-632-L	.140\"		970200007300
KFH-832-L	.166\"		970200008300
KFH-032-L	.191\"		970200009300

Part Number	D +0.08mm	Punch Part No.	Anvil Part No.*
KFH-M3-L	3.1mm	975200048	970200229300
KFH-M4-L	4.1mm		970200019300
KFH-M5-L	5.1mm		970200008300

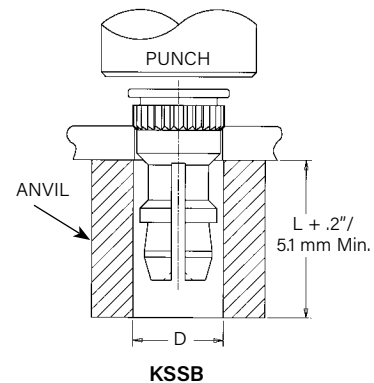

### PEMSERTER® Installation Tooling (1)

Part Number	D +.003\" - .000\"/ +0.08mm	Punch Part No.	Anvil for material .050\" / 1.27mm to .065\" / 1.65mm	Anvil for material greater than .065\" / 1.65mm
KSSB-156-L	.216\"	975200048	8022167	970200015300
KSSB-4mm-L	5.49mm			

(1) [Click here](#) for a quote on Haeger® custom installation tooling.

### KFB3™ Fasteners

1. Prepare properly sized mounting hole in board.
2. Place fastener into the anvil hole and place the mounting hole over the shank of the fastener as shown in diagram.
3. Using a punch flaring tool and a recessed anvil, apply squeezing force until the shoulder of the fastener contacts the board. As the fastener seats itself in the proper position, the punch tool will flare the extended portion of the shank outward to complete the installation. The combination of broaching and flaring provides high pushout performance.

#### PEMSERTER® Installation Tooling <sup>(1)</sup>

Thread Size	Length Code	Anvil	Punch (Flaring Tool)
#4-40	-2	975201213300	975201231400
#4-40	-4 to -8	975200846300	
#4-40	-10 to -12	975200847300	
#4-40	-16 to -20	975200848300	
#4-40	-20 to -24	975200882300	
#6-32	-2	975201215300	975201232400
#6-32	-4 to -8	975200849300	
#6-32	-10 to -12	975200850300	
#6-32	-16 to -20	975200851300	
#6-32	-22 to -24	975200883300	
#6-32	-28 to -32	975200884300	
#10-32	-2	8026682	8026680
#10-32	-4 to -8	8026683	
#10-32	-10 to -12	8026684	
#10-32	-16 to -20	8026685	
#10-32	-20 to -24	8026686	
#10-32	-28 to -32	8026687	
1/4-20	-2	8026688	8026681
1/4-20	-4 to -8	8026689	
1/4-20	-10 to -12	8026690	
1/4-20	-16 to -20	8026691	
1/4-20	-20 to -24	8026692	
1/4-20	-28 to -32	8026693	

Thread Size	Length Code	Anvil	Punch (Flaring Tool)
M3	-2	975201213300	975201231400
M3	-3 to -6	975200846300	
M3	-8 to -10	975200847300	
M3	-12 to -14	975201222300	
M3	-14 to -16	975200848300	
M4	-2	975201216300	975201221400
M4	-3 to -6	975201217300	
M4	-8 to -10	975201218300	
M4	-12 to -14	975201220300	
M4	-14 to -16	975201219300	
M5	-2	8026670	8026680
M5	-3 to -6	8026671	
M5	-8 to -10	8026672	
M5	-12 to -14	8026673	
M5	-14 to -16	8026674	
M6	-2	8026675	8026681
M6	-3 to -6	8026676	
M6	-8 to -10	8026677	
M6	-12 to -14	8026678	
M6	-14 to -16	8026679	

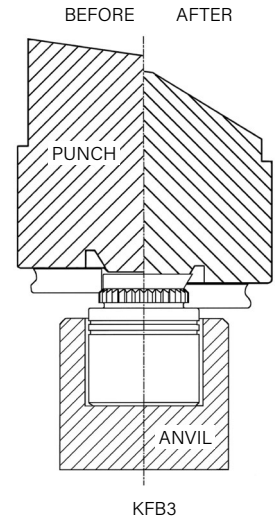

(1) PennEngineering manufactures and stocks the installation tooling for KFB3 fasteners. [Click here](#) for a quote on Haeger® custom installation tooling.

### SFK™ Fasteners

- Step 1. Prepare properly sized mounting hole in both panels.
- Step 2. Using only Panel 1, with the punch and anvil surfaces parallel, apply squeezing force until the fastener is flush with the top of Panel 1.
- Step 3. Place Panel 2 over fastener and apply squeezing force.

#### PEMSERTER® Installation Tooling <sup>(1)</sup>

Size	C ±0.13/±.003 (mm) / (in.)	Punch Part No.	Anvil Part No.*
SFK-3	3.05 / .120	975200048	970200229300
SFK-5	5.05 / .199	975200048	970200020300

\* Part number for anvil used in Step 2

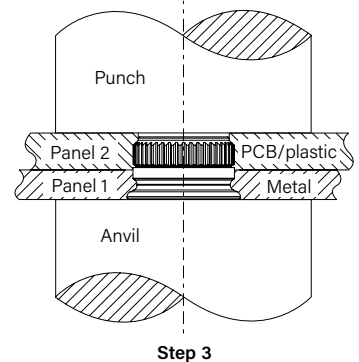
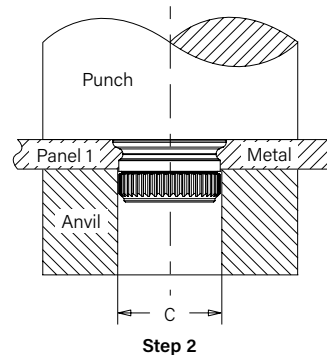

NOTE: Fastener can be installed in both sheets at once when metal panel is adequately soft compared to the non-metal panel. E-mail [techsupport@pemnet.com](mailto:techsupport@pemnet.com) for more information.

(1) [Click here](#) for a quote on Haeger® custom installation tooling.

#### Installation Notes

- For best results we recommend using a HAEGER® or PEMSERTER® press for installation of PEM self-clinching fasteners. Please check our website for more information.
- Visit the Animation Library on our website to view the installation process [for select products](#).

## Installation

### SMTSO™ Nuts And Standoffs

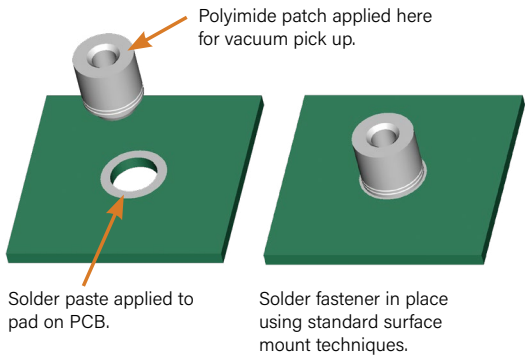

### Smtra™ R'angle® Fasteners

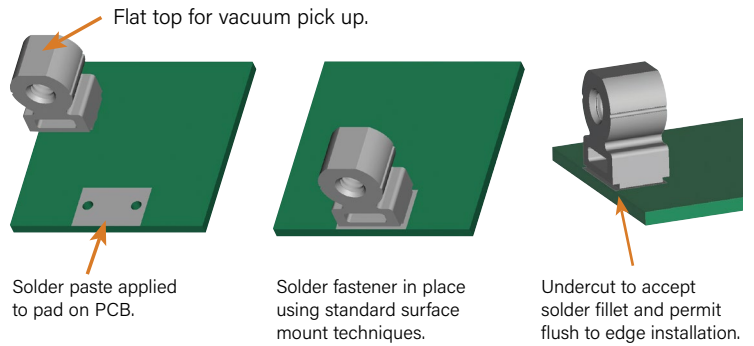

### SMTPF™ Captive Panel Screws

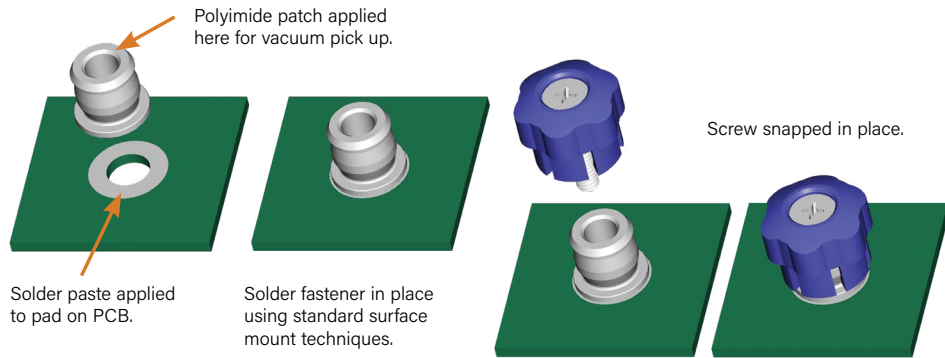

### SMTBSO™ Fasteners

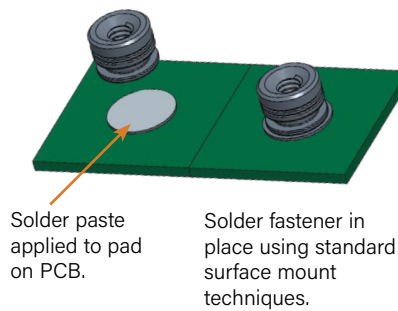

### SMTPFSLM™ Captive Panel Screws

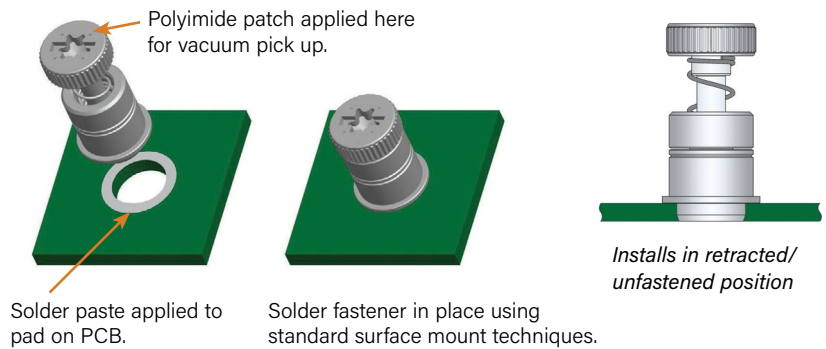

### SMTSS™ Standoffs

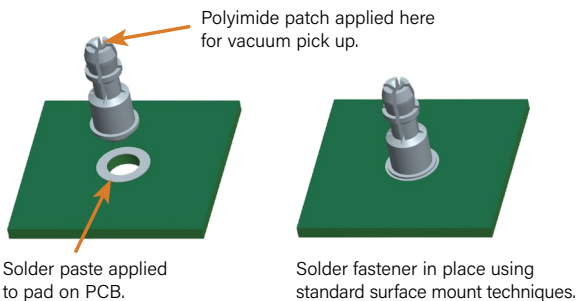

### SMTSK™ Standoffs

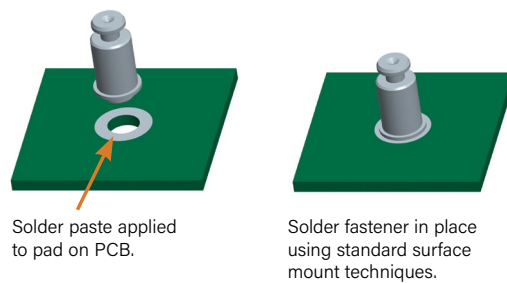

For Additional HAEGER® and PEMSERTER® Tooling Information / Part Numbers



HAEGER® MANUAL TOOLING CATALOG

HAEGER® AUTO TOOLING CATALOG

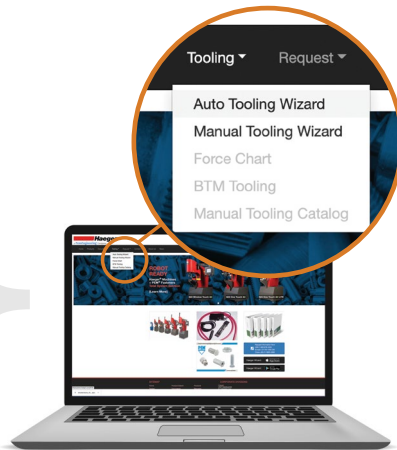

Go to [haeger.com](http://haeger.com) to access the Auto and Manual Tooling Wizards

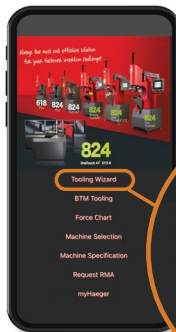

Or download the HAEGER WIZZARD Phone App

Tooling Wizard

BTM Tooling



PEMSERTER® MANUAL TOOLING CATALOG

PEMSERTER® AUTO TOOLING CATALOG

Performance Data<sup>(1)</sup>

## KF2™/KFS2™/KFE™/KFSE™/KFB3™/KFH™/PFK™ Broaching And Broach/Flare Mount Fasteners

Unified	Type	Thread Code	Max. Nut Tightening Torque (in. lbs.)	Test Sheet Thickness & Test Sheet Material	Installation (lbs.)	Pushout <sup>(2)</sup> (lbs.)	Torque-out (in. lbs.)	Rated Current Amps (5)	
	KF2, KFS2 KFE, KFSE		256	(3)	.060" FR-4 Panel	400	60	6	–
			440	(3)	.060" FR-4 Panel	400	65	15	–
			632	(3)	.060" FR-4 Panel	500	80	30	–
			832	(3)	.060" FR-4 Panel	700	95	35	–
			032	(3)	.060" FR-4 Panel	700	100	40	–
	KFB3		440	(3)	.060" FR-4 Panel	1000	140	18	42
			632	(3)	.060" FR-4 Panel	1500	170	28	88
			032	(3)	.060" FR-4 Panel	1600	180	30	100
			0420	(3)	.060" FR-4 Panel	1700	188	42	150
KFH		440	4	.060" FR-4 Panel	400	65	7	14	
		632	8	.060" FR-4 Panel	400	70	11	19	
		832	15	.060" FR-4 Panel	400	80	16	24	
		032	18	.060" FR-4 Panel	400	90	17	30	
PFK		440	(3)	.060" FR-4 Panel	250	55	(3)	–	
		632	(3)	.060" FR-4 Panel	400	60	(3)	–	

Metric	Type	Thread Code	Max. Nut Tightening Torque (N-m)	Test Sheet Thickness & Test Sheet Material	Installation (kN)	Pushout <sup>(2)</sup> (N)	Torque-out (N-m)	Rated Current Amps (5)	
	KF2, KFS2 KFE, KFSE		M2	(3)	1.5 mm FR-4 Panel	2.2	267	0.68	–
			M3	(3)	1.5 mm FR-4 Panel	2.2	290	1.7	–
			M4	(3)	1.5 mm FR-4 Panel	2.2	420	3.4	–
			M5	(3)	1.5 mm FR-4 Panel	2.9	440	4.5	–
	KFB3		M3	(3)	1.5 mm FR-4 Panel	4.4	560	2.03	42
			M4	(3)	1.5 mm FR-4 Panel	6	680	3.2	88
			M5	(3)	1.5 mm FR-4 Panel	7.1	800	3.5	100
			M6	(3)	1.5 mm FR-4 Panel	7.6	835	4.8	150
	KFH		M3	0.45	1.5 mm FR-4 Panel	1.8	285	0.79	15
		M4	1.6	1.5 mm FR-4 Panel	1.8	355	1.8	23	
		M5	2.1	1.5 mm FR-4 Panel	1.8	400	1.92	32	
PFK		M3	(3)	1.5 mm FR-4 Panel	1.1	245	(3)	–	

## KSSB™ Broaching Snap-Top® Standoffs

Unified	Type	Panel 1 (.060" FR-4 Fiberglass) <sup>(4)</sup>		Panel 2 (Removable) <sup>(4)</sup>		
		Installation (lbs.)	Pushout (lbs.)	Max. First On Force (lbs.)	Min. First Off Force (lbs.)	Min. 15th Off Force (lbs.)
	KSSB	500	110	13	3.0	1.0

Metric	Type	Panel 1 (1.5 mm FR-4 Fiberglass) <sup>(4)</sup>		Panel 2 (Removable) <sup>(4)</sup>		
		Installation (kN)	Pushout (N)	Max. First On Force (N)	Min. First Off Force (N)	Min. 15th Off Force (N)
	KSSB	2.2	484	57.7	13.3	4.4

- (1) Published installation forces are for general reference. Actual set-up and confirmation of complete installation should be made by observing proper seating of fastener as described in the installation steps. Other performance values reported are averages when all proper installation parameters and procedures are followed. Variations in mounting hole size, sheet material, and installation procedure may affect performance. Performance testing this product in your application is recommended. We will be happy to provide technical assistance and/or samples for this purpose.
- (2) These are typical values for parts installed in drilled mounting holes. Punched mounting holes yield values approximately 15% less.
- (3) Not applicable.
- (4) See Application Data drawing on page 10.
- (5) The maximum carrying current for each of the above fasteners is calculated based on a heat transfer coefficient of 20 W/m<sup>2</sup> °K and a maximum temperature rise of 15°C / 27°F above ambient.

**SFK™ SpotFast® Clinch/Broach Mount Fasteners**

Type and Size	Thick-ness Code	Installation into Panel 1		Installation into Panel 2		Pushout of Panel 2 <sup>(3)</sup>	
		Cold-rolled Steel		FR-4 Fiberglass		N      lbs.	
		kN	lbs.	kN	lbs.		
SFK-3	0.8	6.2	1400	1.8	400	200	45
SFK-3	1.0	8	1800	1.8	400	200	45
SFK-3	1.2	8.9	2000	1.8	400	200	45
SFK-3	1.6	10.2	2300	1.8	400	200	45
SFK-5	0.8	11.1	2500	1.8	400	400	90
SFK-5	1.0	13.5	3000	1.8	400	400	90
SFK-5	1.2	15.6	3500	1.8	400	400	90
SFK-5	1.6	17.8	4000	1.8	400	400	90

**SMTSS™ ReelFast® SNAP-TOP® Standoffs<sup>(1)(2)</sup>**

Type, Material and Size	Panel 1 (Bottom)		Panel 2 (Top)
	Test Sheet Material	Pushout	Max. Snap-on Force
	SMTSS-156	.062" Single Layer FR-4	113 lbs.
SMTSS-4MM	1.58 mm Single Layer FR-4	500 N	89 N

**SMTSK™ Keyhole® Standoffs<sup>(1)(2)</sup>**

Type and Size	Panel 1 (Bottom)	
	Test Sheet Material	Pushout
	SMTSK-6060	.062" Single Layer FR-4
SMTSK-61.5	1.58 mm Single Layer FR-4	500 N

**SMTSO™/SMTSOB™ Fasteners<sup>(1)(2)</sup>**

Type	Thread/Thru-hole Code	Test Sheet Material - .062" Single Layer FR-4				Rated Current Amps <sup>(6)</sup>
		Pushout (lbs.)	Pushout (N)	Torque-out (in. lbs.)	Torque-out (N-m)	
SMTSO	080	85.1	378.7	4.94	0.56	11
SMTSOB						—
SMTSO	256	56.5	251	8.56	1	25
SMTSOB						40
SMTSO	440	56.5	251	8.56	1	22
SMTSOB						36
SMTSO	632	93.5	416	13.83	1.6	34
SMTSOB						55
SMTSO	832	151.1	672	26.96	3	47
SMTSOB						76
SMTSO	116	—	—	—	—	22
SMTSOB		37				
SMTSO	143	—	—	—	—	33
SMTSOB		55				
SMTSO	M1	85.1	378.7	4.94	0.56	11
SMTSOB						—
SMTSO	M1.2	85.1	378.7	4.94	0.56	10
SMTSOB						—
SMTSO	M1.4	85.1	378.7	4.94	0.56	10
SMTSOB						—
SMTSO	M1.6	85.1	378.7	4.94	0.56	10
SMTSOB						—
SMTSO	M3	56.5	251	8.56	1	22
SMTSOB						36
SMTSO	M3.5	93.5	416	13.83	1.6	34
SMTSOB						55
SMTSO	M4	151.1	672	26.96	3	47
SMTSOB						76
SMTSO	3.1	—	—	—	—	22
SMTSOB		36				
SMTSO	3.6	—	—	—	—	33
SMTSOB		55				
SMTSO	4.2	—	—	—	—	46
SMTSOB		75				

**SMTRA™ R'ANGLE® Fasteners<sup>(1)(2)</sup>**

Unified	Part Number	Test Sheet Material - .062" Single Layer FR-4	
		Pushout (lbs.)	Side Load (lbs.)
	SMTRA256-8-6	51.7	71
SMTRA440-9-6	89.5	10.8	
SMTRA632-10-8	110.3	8.4	
SMTRA832-12-9	1372	21.2	

Metric	Part Number	Test Sheet Material - 1.58 mm Single Layer FR-4	
		Pushout (N)	Side Load (N)
	SMTRAM2-6-5	418.2	56.8
SMTRAM25-6-5	216.5	36.9	
SMTRAM3-7-5	257.6	41.3	
SMTRAM4-9-7	369.3	73.3	

**SMTBSO™ Fasteners<sup>(1)</sup>**

Part Number	Test Sheet Material - .062"/1.58mm Single Layer FR-4				Rated Current Amps <sup>(6)</sup>
	Pull Off (lbs.)	Pull Off (N)	Torque-out (lbs.)	Torque-out (N-m)	
SMTBSO-440-6	61	—	15.4	—	12
SMTBSO-M3-4	—	270	—	1.75	22

**Testing Conditions For Surface Mounted Fasteners**

<b>Oven</b>	Quad ZCR convection oven w/ 4 zones	<b>Spokes</b>	2 Spoke Pattern
<b>High Temp</b>	473°F / 245°C	<b>Paste</b>	Amtech NC559LF Sn96.5/3.0Ag/0.5Cu (SAC305) (SMTSO, SMTRA, SMTPR)
<b>Board Finish</b>	62% Sn, 38% Pb		Alpha CVP-390 Sn96.5/3.0Ag/0.5Cu (SAC305) (SMTPF LSM, SMTSS, SMTSK, SMTBSO)
<b>Screen Printer</b>	Ragin Manual Printer	<b>Stencil</b>	.0067" / 0.17 mm thick (SMTSO, SMTRA, SMTPR, SMTSS, SMTSK, SMTBSO)
<b>Vias</b>	None		.005" / 0.13 mm thick (SMTPF LSM)

- (1) With lead-free paste. Average values of 30 test points. The data presented here is for general comparison purposes only. Actual performance is dependent upon application variables. We will be happy to provide samples for you to install. If required, we can also test your installed hardware and provide you with the performance data specific to your application.
- (2) Further testing details can be found in our website's literature section.
- (3) In most applications, pullout strength of the SFK fastener in Panel 1 exceeds pushout strength of Panel 2.
- (4) Torque values shown will produce a preload of 70% minimum tensile with a nut factor "k" equal to .1.
- (5) Failure occurred at the solder joint. Screw retention strength is greater than the retainer.
- (6) The maximum carrying current for each of the above fasteners is calculated based on a heat transfer coefficient of 20 W/m<sup>2</sup> °K and a maximum temperature rise of 15°C / 27°F above ambient.



SMTPFSLM™ Fasteners<sup>(1)</sup>

Unified	Type and Thread Size	Min. Tensile Strength (lbs.)	Rec. Tightening Torque (in. lbs.) (4)	Test Sheet Material	
				.060" P.C. Board	
				Pushout (lbs.) (5)	Pull-off (lbs.) (5)
	SMTPFSLM-440	556	4.4	100	
	SMTPFSLM-632	724	7.0	105	

Metric	Type and Thread Size	Min. Tensile Strength (N)	Rec. Tightening Torque (N-m) (4)	Test Sheet Material	
				1.5 mm P.C. Board	
				Pushout (N) (5)	Pull-off (N) (5)
	SMTPFSLM-M3	2900	0.61	445	
	SMTPFSLM-M3.5	3269	0.8	465	

SMTPR™ Retainers<sup>(1)</sup>

Part Number	Test Sheet Material - .062" Single Layer FR-4	
	Pushout (lbs.)	Pushout (N)
SMTPR-6-IET	161.4	718

Testing Conditions For Surface Mounted Fasteners

- Oven** Quad ZCR convection oven w/ 4 zones
- High Temp** 473° F / 245° C
- Board Finish** 62% Sn, 38% Pb
- Screen Printer** Ragin Manual Printer
- Vias** None
- Spokes** 2 Spoke Pattern
- Paste** Amtech NC559LF Sn96.5/3.0Ag/0.5Cu (SAC305) (SMTSO, SMTRA, SMTPR)  
Alpha CVP-390 Sn96.5/3.0Ag/0.5Cu (SAC305) (SMTPFSLM, SMTSS, SMTSK)
- Stencil** .0067" / 0.17 mm thick (SMTSO, SMTRA, SMTPR, SMTSS, SMTSK)  
.005" / 0.13 mm thick (SMTPFSLM)

- (1) With lead-free paste. Average values of 30 test points. The data presented here is for general comparison purposes only. Actual performance is dependent upon application variables. We will be happy to provide samples for you to install. If required, we can also test your installed hardware and provide you with the performance data specific to your application.
- (2) Torque values shown will produce a preload of 70% minimum tensile with a nut factor "k" equal to 1.
- (3) Failure occurred at the solder joint. Screw retention strength is greater than the retainer.

SMTSO™ Reflow Curve

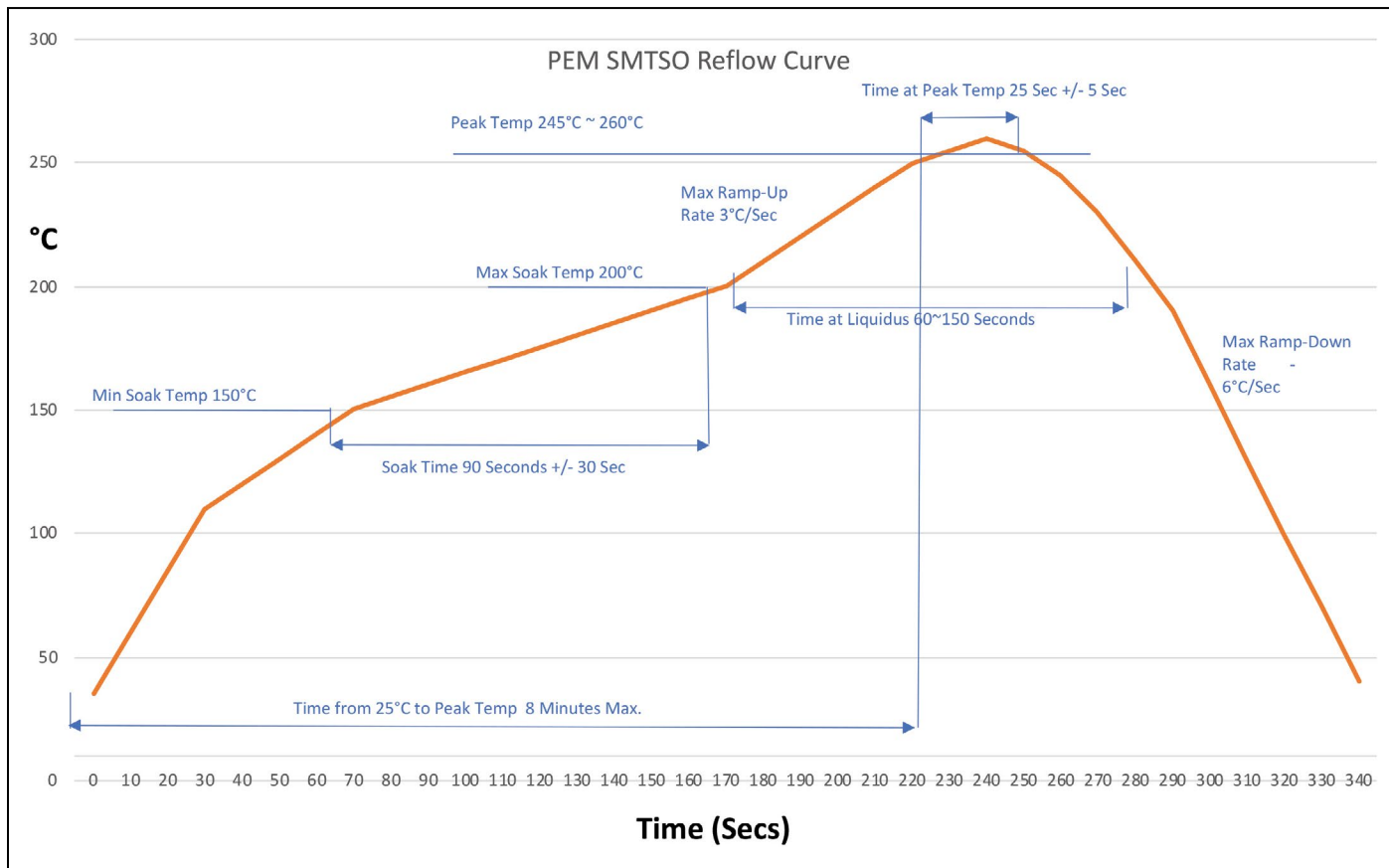

## Other Fasteners For Consideration To Use With PC Boards

### PF11MW™ Floating Captive Panel Screws

#### (See PEM® Bulletin PF)

Unique flare mount feature allow fasteners to “float” in mounting hole.

- Compensates for mating thread misalignment.
- Installs into any panel material.
- Appropriate for close center-line-to-edge applications.
- Color coded knobs available.



### PF11MF™ Flare-Mounted Captive Panel Screws

#### (See PEM® Bulletin PF)

- Appropriate for close centerline-to-edge applications.
- Doesn't require high installation force.
- Installs into any panel material.
- Installs flush on back side of panel.
- Color coded knobs available.

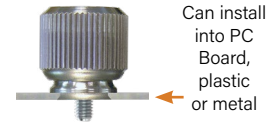

### SGPC™ Swaging Collar Studs

#### (See PEM® Bulletin FH)

- Can be installed into most materials, including stainless steel and rigid non-metallic panels.
- Can be used to attach dissimilar materials.
- Can accommodate multiple panels as long as the total thickness does not exceed the maximum sheet thickness.
- Appropriate for close center-line-to-edge applications.

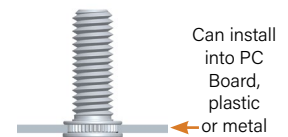

### SOAG™/SOSG™ Grounding Standoffs

#### (See PEM® Bulletin SO)

- Designed for clinching into steel or aluminum chassis.
- “Gripping teeth” on opposite side of standoff makes firm electrical contact with mating PC Board.

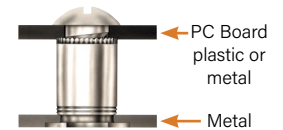

### SKC™ Keyhole® Standoffs

#### (See PEM® Bulletin SK)

- Clinch feature mounts fastener permanently into metal sheet.
- Allows for quick attachment and detachment of PC Board.
- Head is flush or sub-flush in metal sheet.
- Makes horizontal or vertical component mounting possible.

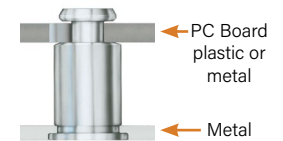

### SSA™/SSC™/SSS™ Snap-Top® Standoffs

#### (See PEM® Bulletin SSA)

- Spring action holds PC Boards and subassemblies securely, while allowing for quick removal.
- Screws and other threaded hardware are eliminated.

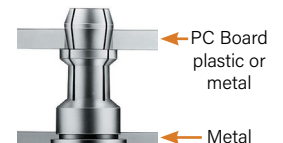

For more information on these and other PEM products, visit our PEMNET™ Resource Center at [www.pemnet.com](http://www.pemnet.com)



All PEM® products meet our stringent quality standards. If you require additional industry or other specific [quality certifications](#), special procedures and/or part numbers are required. Please contact your local sales office or representative for further information.

Regulatory [compliance information](#) is available in Technical Support section of our website. Specifications subject to change without notice. See our website for the most current version of this bulletin.



**North America:** Danboro, Pennsylvania USA | E-mail: [info@pemnet.com](mailto:info@pemnet.com) | Tel: +1-215-766-8853 | 800-237-4736 (USA)

**Europe:** Galway, Ireland | E-mail: [europa@pemnet.com](mailto:europa@pemnet.com) | Tel: +353-91-751714

**Asia/Pacific:** Singapore | E-mail: [singapore@pemnet.com](mailto:singapore@pemnet.com) | Tel: +65-6-745-0660

**Shanghai, China:** E-mail: [china@pemnet.com](mailto:china@pemnet.com) | Tel: +86-21-5868-3688

Visit our PEMNET™ Resource Center at [www.pemnet.com](http://www.pemnet.com) • Technical support e-mail: [techsupport@pemnet.com](mailto:techsupport@pemnet.com)