



PEM® VariMount® bonding fasteners are assemblies comprised of standard PEM® fasteners mounted permanently into base plates.



**VM™**

## PEM® VARIMOUNT® BONDING FASTENERS

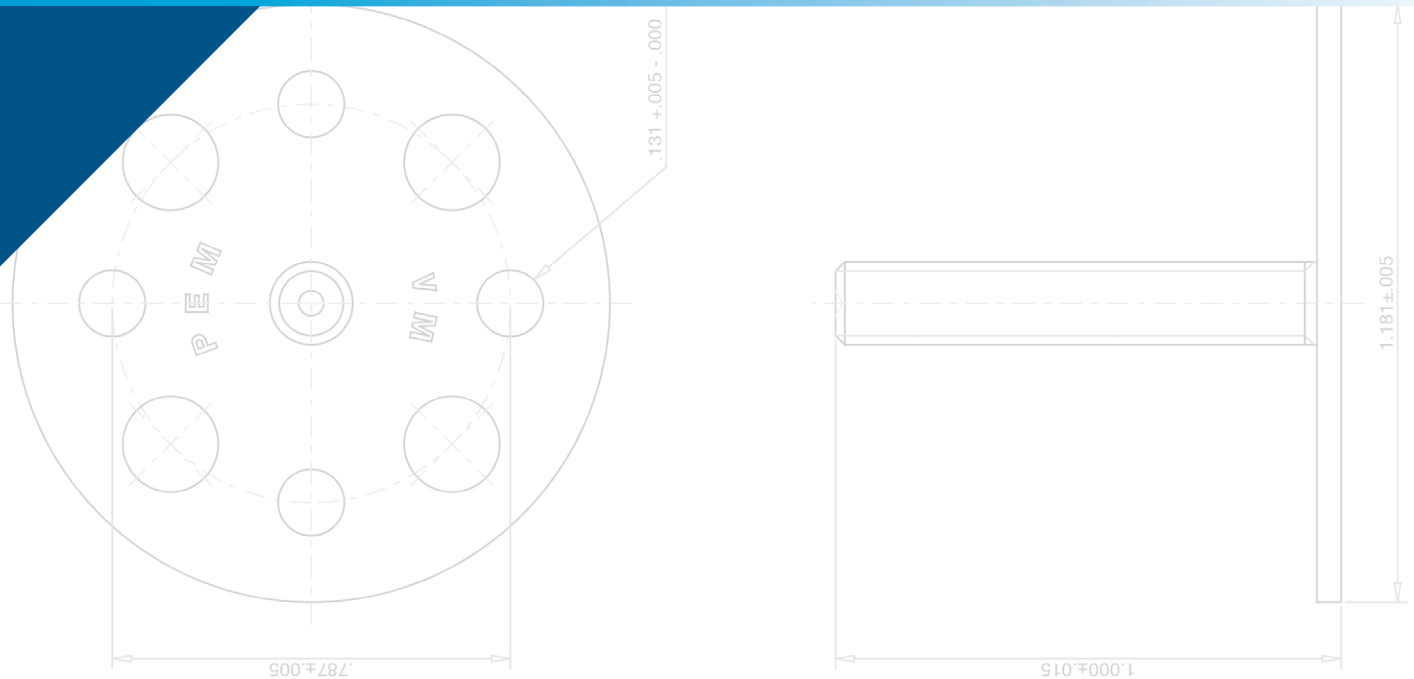

# PEM® VARIMOUNT® BONDING FASTENERS

The PEM® VariMount® fastening system is an assembly comprised of a standard PEM® nuts, studs or standoffs mounted permanently into a base plate. The assembly can then be fastened or bonded to assorted panel types in a variety of ways:

## Mounting Methods:

- Mold-in
- Laminate within composite layers
- Surface bonding
- Rivets
- Loose hardware (nuts, bolts, screws)
- Self-clinching fasteners
- Blind threaded rivets
- Hollow wall anchors
- Spot welding

## Mounts on or in:

- Composites
- Plastics
- Metal
- Wall board
- Any rigid material or panel

VariMount® assemblies are available with either steel or stainless steel base plates depending on the fastener that is selected. The VariMount® base plate's radial holes provide various mounting options.

Base plates can also be purchased separately. See page 5 for dimensional data and part numbers.

## VARIMOUNT® ASSEMBLY USING SELF-CLINCHING TECHNOLOGY

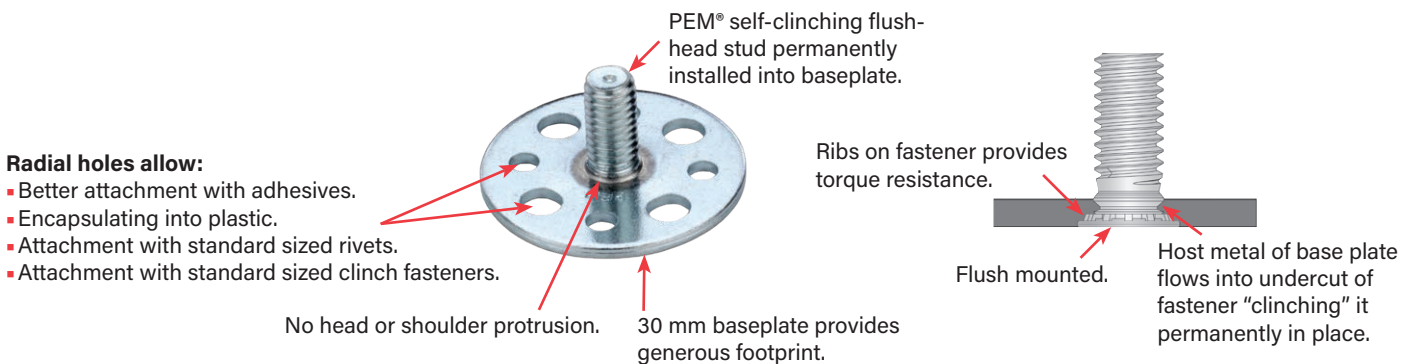

## TYPICAL MOUNTING METHODS

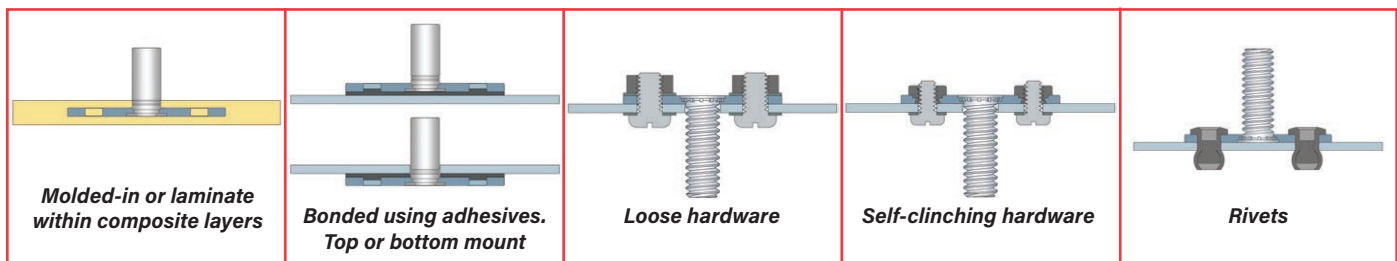

## ASSEMBLY PART NUMBER DESIGNATION

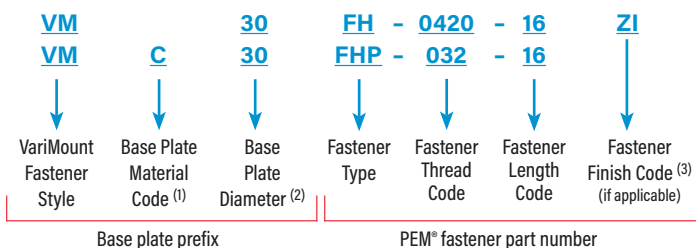

A VariMount® assembly part number includes a base plate prefix paired with a standard PEM® fastener part number.

(1) "Blank" equals steel base plate and "C" equals stainless steel base plate.

(2) See page 5 for complete dimensional information.

(3) Required on steel assemblies.

# PEM® VARIMOUNT® BONDING FASTENERS

The charts below show PEM® fastener types/sizes that are offered as standard VariMount® assemblies.

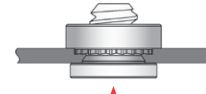
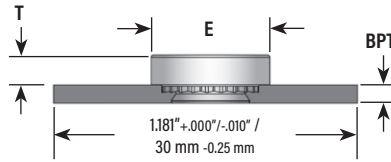

## STANDARD NUTS

All dimensions are in inches.

UNIFIED	Thread Size	Type and Material		Thread Code	Shank Code	BPT ±.004	E ±.010	T ±.010
		Steel	Stainless Steel					
	.112-40 (#4-40)	VM30S-	VMC30SP-	440	1	.048	.250	.070
	.138-32 (#6-32)	VM30S-	VMC30SP-	632	1	.048	.280	.070
	.164-32 (#8-32)	VM30S-	VMC30SP-	832	1	.048	.310	.090
	.190-32 (#10-32)	VM30SS-	VMC30SP-	032	2	.063	.340	.090

All dimensions are in millimeters.

METRIC	Thread Size x Pitch	Type and Material		Thread Code	Shank Code	BPT ±0.1	E ±0.25	T ±0.25
		Steel	Stainless Steel					
	M3 x 0.5	VM30S-	VMC30SP-	M3	1	1.2	6.35	1.5
	M4 x 0.7	VM30S-	VMC30SP-	M4	1	1.2	7.87	2
	M5 x 0.8	VM30SS-	VMC30SP-	M5	2	1.6	8.64	2

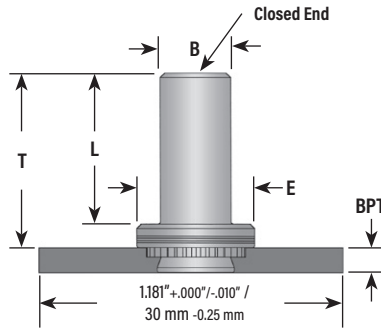

## BLIND NUTS

All dimensions are in inches.

UNIFIED	Thread Size	Type and Material	Thread Code	Shank Code	BPT ±.004	B Max.	E ±.010	L Max.	T ±.010
		Steel							
	.112-40 (#4-40)	VM30B-	440	1	.048	.150	.250	.335	.380
	.138-32 (#6-32)	VM30B-	632	1	.048	.169	.280	.335	.380
	.164-32 (#8-32)	VM30B-	832	1	.048	.204	.310	.385	.440
	.190-32 (#10-32)	VM30B-	032	2	.063	.235	.340	.385	.440

All dimensions are in millimeters.

METRIC	Thread Size x Pitch	Type and Material	Thread Code	Shank Code	BPT ±0.1	B Max.	E ±0.25	L Max.	T ±0.25
		Steel							
	M3 x 0.5	VM30B-	M3	1	1.2	3.84	6.35	8.5	9.6
	M4 x 0.7	VM30B-	M4	1	1.2	5.2	7.95	9.8	11.2
	M5 x 0.8	VM30B-	M5	2	1.6	6.02	8.75	9.8	11.2



# PEM® VARIMOUNT® BONDING FASTENERS

The charts below show PEM® fastener types/sizes that are offered as standard VariMount® assemblies.

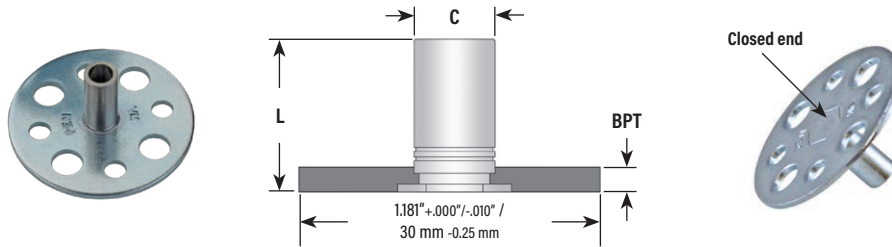

## STANDOFFS

All dimensions are in inches.

UNIFIED	Thread Size	Type and Material		Thread Code	Length Code "L" +.002 -.005 (Length code in 32nds of an inch)						BPT ±.004	C +.000 -.005	
		Steel			.375	.437	.500	.562	.625	.687			.750
	.112-40 (#4-40)	VM30BSO-		440	12	14	16	18	20	22	24	.048	.165
	.138-32 (#6-32)	VM30BSO-		632	12	14	16	18	20	22	24	.048	.212

All dimensions are in inches.

METRIC	Thread Size x Pitch	Type and Material		Thread Code	Length Code "L" +0.05 -.13 (Length code in millimeters)						BPT ±0.1	C -0.13
		Steel			12	14	16	18	16	18		
	M3 x 0.5	VM30BSO-		M3	12	14	16	18	16	18	1.2	4.2
	M3.5 x 0.6	VM30BSO-		M3.5	12	14	16	18	16	18	1.2	5.39

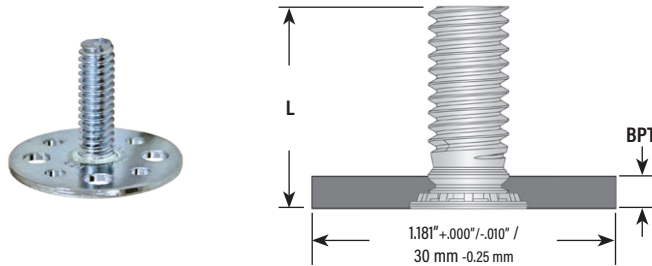

## STUDS

All dimensions are in inches.

UNIFIED	Thread Size	Type and Material		Thread Code	Length Code "L" ±.015 (Length code in 16ths of an inch)						BPT ±.004
		Steel	Stainless Steel		.500	.625	.750	.875	1.00	1.25	
	.164-32 (#8-32)	VM30FH-	VMC30FHP-	832	8	10	12	14	16	20	.048
	.190-32 (#10-32)	VM30FH-	VMC30FHP-	032	8	10	12	14	16	20	.048
	.250-20 (1/4-20)	VM30FH-	—	0420	8	10	12	14	16	20	.067

All dimensions are in inches.

METRIC	Thread Size x Pitch	Type and Material		Thread Code	Length Code "L" ±0.4 (Length code in millimeters)						BPT ±0.1
		Steel	Stainless Steel		10	12	15	18	20	25	
	M4 x 0.7	VM30FH-	VMC30FHP-	M4	10	12	15	18	20	25	1.2
	M5 x 0.8	VM30FH-	VMC30FHP-	M5	10	12	15	18	20	25	1.2
	M6 x 1	VM30FH-	—	M6	10	12	15	18	20	25	1.7



# PEM® VARIMOUNT® BONDING FASTENERS

## BASE PLATE PART NUMBER, DIMENSIONS AND MATERIAL GUIDE

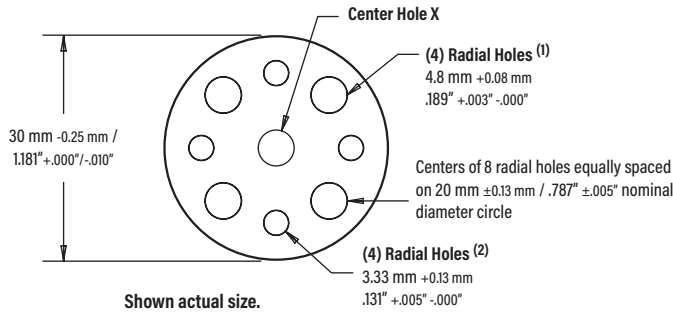

### BASE PLATE PART NUMBER DESIGNATION

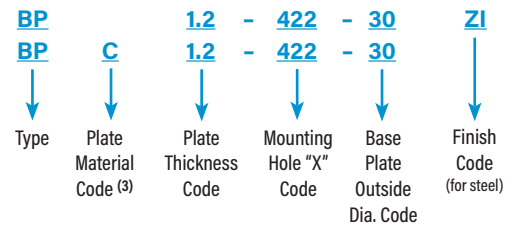

Base Plate Part Number (4)		Thickness ±0.1 mm / ±.004"	Center Hole X Diameter +0.08 mm / +.003" -.000"
Steel (5)	Stainless Steel (6)		
BP1.2-422-30ZI	BPC1.2-422-30	1.2 mm / .048"	4.22 mm / .166"
BP1.2-480-30ZI	BPC1.2-480-30	1.2 mm / .048"	4.8 mm / .189"
BP1.2-541-30ZI	BPC1.2-541-30	1.2 mm / .048"	5.41 mm / .213"
BP1.6-635-30ZI	BPC1.6-635-30	1.6 mm / .063"	6.35 mm / .250"
BP1.2-400-30ZI	BPC1.2-400-30	1.2 mm / .048"	4 mm / .1575"
BP1.2-500-30ZI	BPC1.2-500-30	1.2 mm / .048"	5 mm / .1969"
BP1.6-600-30ZI	BPC1.6-600-30	1.6 mm / .063"	6 mm / .2362"
BP1.7-600-30ZI	BPC1.7-600-30	1.7 mm / .067"	6 mm / .2362"

- (1) Accepts standard M3.5 / #6-32 self-clinching nuts. Also flush-head studs #10-24 / #10-32 sizes. May also accept 4.8 mm / 3/16" rivet.
- (2) Standard hole size for 3.2 mm / 1/8" rivet.
- (3) "Blank" equals steel base plate and "C" equals stainless steel base plate.
- (4) Use this part number if ordering base plate separately. Minimum quantities may apply.
- (5) Base plate is carbon steel, zinc plated 5µm, colorless.
- (6) Base plate is 300 series stainless steel, passivated and/or tested per ASTM A380.

### NOTE ABOUT PERFORMANCE

General performance of PEM® fasteners in thin metal panels can be found in their respective PEM® Bulletins. Performance of the assembly (fastener and base plate) mounted to your specific material, in your application will have to be determined by testing. We recommend that you perform testing to be sure it is ideally suited to your application. We will be happy to provide technical assistance and/or samples to you for this purpose.

Look for the trademarks to identify genuine PEM® fasteners.

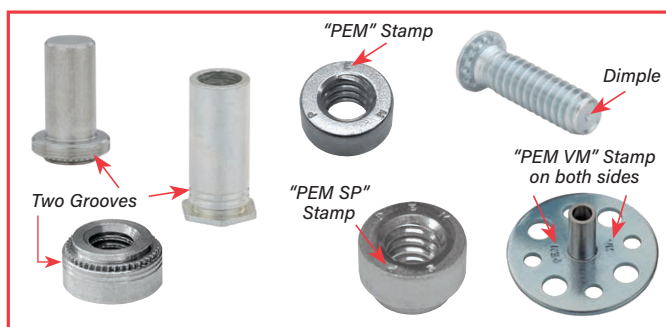

Drawings and models for parts listed on pages 3, 4 & 5 are available at [www.pemnet.com](http://www.pemnet.com)

# PEM® VARIMOUNT® BONDING FASTENERS

## OTHER PEM® FASTENER TYPES AND SIZES AVAILABLE \*

While we have listed the standard offering of assemblies on the charts (pages 3 and 4), other PEM® fasteners can be provided pre-installed into one of the base plates listed on page 5. The charts below give a review of these fastener types. To choose an assembly using one of these fasteners, simply create a part number as described on page 2.

PEM® Fastener Types	Standard Size Codes
<b>Self-clinching Nuts</b>	
BS	440 / 632 / 832 / 032 / M3 / M4 / M5
CLS	256 / 348 / 440 / 632 / 832 / M2 / M2.5 / M3 / M3.5 / M4
CLSS	024 / 032 / M5
LK, LKS	440 / M3
PL, PLC	M3
S	256 / 348 / M2 / M2.5 / M3.5
SL	440 / 632 / 832 / 032 / M3 / M3.5 / M4 / M5
<b>SP</b>	256 / 024
SS	024
<b>Self-clinching Studs</b>	
FH	024 / Non-threaded
<b>FH4</b>	832 / 032 / 0420 / M4 / M5 / M6
FHS	832 / 024 / 032 / 0420 M4 / M5 / M6 / Non-threaded
HFE	032 / 0420 / M5 / M6
HFH, HFHS	0420 / M6

PEM® Fastener Types	Standard Size Codes
<b>Self-clinching Standoffs</b>	
BS0, BS0S, <b>BS04</b>	440 / 632 / 6440 / M3 / 3.5M3 / M3.5
DS0, DS0S	440 / M3
SO, <b>S04</b>	6440 / 3.5M3 / M3.5 / Non-threaded
SOS	440 / 632 / 6440 / 3.5M3 / M3 / M3.5 / Non-threaded
SOSG	6440 / 3.5M3
SSC, SSS	156 / 4MM
<b>Panel Fasteners</b>	
N10	440 / 632 / 832 / M3
PF11, PF12, PF11M, PF12M	632
<b>PF11MF, PF12MF</b>	440 / M3
<b>PF11MW, PF12MW</b>	440 / M3
PF11PM	632
PF30	832
PF31, PF32	832 / M4
PF50, PF51, PF52, PF60, PF61, PF62	832 / M4
PF7M	632
<b>PF7MF</b>	440 / M3
SCB, SCBJ	M4
SCBR	832 / M4

*Types shown in bold italics can be installed into stainless steel base plates. Other types are not recommended for installation into stainless steel base plates.*



**Micro Sized Options Available**

\* Other fasteners, base plate configurations and assemblies are available on special order. For questions, please contact our global technical support team using the contact information listed at the bottom of this page. Appropriate minimum quantities may apply.

All PEM® products meet our stringent quality standards. If you require additional industry or other specific [quality certifications](#), special procedures and/or part numbers are required. Please contact your local sales office or representative for further information.

Regulatory [compliance information](#) is available in Technical Support section of our website. Specifications subject to change without notice. See our website for the most current version of this bulletin.

**PennEngineering®**



**North America:** Danboro, Pennsylvania USA • E-mail: [info@pemnet.com](mailto:info@pemnet.com) • Tel: +1-215-766-8853 • 800-237-4736 (USA)

**Europe:** Galway, Ireland • E-mail: [europa@pemnet.com](mailto:europa@pemnet.com) • Tel: +353-91-751714

**Asia/Pacific:** Singapore • E-mail: [singapore@pemnet.com](mailto:singapore@pemnet.com) • Tel: +65-6-745-0660

Shanghai, China • E-mail: [china@pemnet.com](mailto:china@pemnet.com) • Tel: +86-21-5868-3688

Visit our PEMNET™ Resource Center at [www.pemnet.com](http://www.pemnet.com) • Technical support e-mail: [techsupport@pemnet.com](mailto:techsupport@pemnet.com)